



MICROBIOLOGY CONTROL PRODUCTS

CULTURE-BASED QC MICROORGANISMS

43rd Edition Retail Catalog

Table of Contents

Clinical Products Reference Guide	1
Food Products Reference Guide	2
Water Products Reference Guide	3
Pharmaceutical Products Reference Guide	4
Molds Reference Guide	5
microbiologics.com	6
Customer Service	6
Technical Support	6
Worldwide Distribution	6
International Customers	6
USA Customers	6
Product Warranty	7
Culture Methods	7
Antimicrobial Resistance Strains	7
Mean Assay Value	7
End User Registration	7
Payment Options	8
Credit Card Purchases	8
Terms	8
Shipping and Delivery	8
Trademarks	8
Culture Purposes and QC Applications	
KWIK-STIK™ and LYFO DISK™	9
QC Sets and Panels	47
Assay and Diagnostic System QC Sets and Panels	48
Regulation-Specific QC Sets and Panels	51
Food and Cannabis QC Sets and Panels	52
Parasite Suspensions and QC Microbiology Slides	
Parasite Suspensions	53
QC Microbiology Slides	56
Certified Reference Material	
Lab-Elite™ CRM	58
Epower™ CRM	63
Food Safety	
UV-BioTAG™ (Controls with Green Fluorescent Protein Tags)	67
EZ-SPORE™	70
Multiple Application Enumeration Challenges	
Epower™	73

Table of Contents

Two Passages from Reference Culture

KWIK-STIK™ Plus 79

Pharmaceutical, Cosmetic and Nutraceutical Products

EZ-Accu Shot™ 84

EZ-Accu Shot™ Select 88

EZ-CFU™ One Step 91

EZ-CFU™ 94

EZ-PEC™ 98

Custom Controls

Custom Solutions 101

Business Solutions 103

Proficiency Solutions 105

Contact Us

Customer Service

Hours: 7:30 a.m. – 5:00 p.m. (CST)

Telephone: 1.320.253.1640

U.S. Toll Free: 1.800.599.BUGS (2847)

Fax: 1.320.253.6250

Email: info@microbiologics.com

Web: www.microbiologics.com

Technical Support

Hours: 8:00 a.m. – 5:00 p.m. (CST)

Telephone: 1.320.229.7045

U.S. Toll Free: 1.866.286.6691

Email: techsupport@microbiologics.com

Clinical Products Reference Guide

Test Methods	KWIK-STIK	KWIK-STIK Plus	LYFO DISK	QC Microbiology Slides	Parasite Suspensions	QC Sets and Panels*	Helix Elite*
Identification Tests/ Traditional Methods	•	•	•	•	•	•	
Identification Tests/ Automated Commercial Instruments	•	•	•			•	•
Identification Tests/ Molecular Methods/ Rapid Methods	•	•	•			•	•
Antimicrobial Susceptibility Tests	•	•	•			•	
Screening Tests for Biomarkers Using Lab Developed Methods							•
Validation/Verification	•	•	•			•	•
Education	•	•	•	•	•	•	•
Proficiency Testing	•	•	•	•	•		•

*Visit microbiologics.com to view all Helix Elite products and molecular QC Sets and Panels

Food Products Reference Guide

Test Methods	Qualitative QC Microorganisms			Quantitative QC Microorganisms		Certified Reference Materials		Custom Solutions
	KWIK-STIK	LYFO DISK	UV-BioTAG	EZ-SPORE	Epower	Epower CRM	Lab-Elite CRM	Your Strain
Presence/Absence Testing and Identification Methods								
Biochemical Tests	•	•			•	•	•	•
Chromogenic Media	•	•			•	•	•	•
PCR Methods	•	•			•	•	•	•
Antibody Methods (e.g., ELISA)	•	•			•	•	•	•
Standard Culture Methods	•	•	•	•	•	•	•	•
Enumeration Tests								
Pour Plate				•	•	•		•
Film-Based Media					•	•		•
Membrane Filtration				•	•	•		•
Most Probable Number (MPN)				•	•	•		•
Spore Plate				•	•	•		
Spiral Autoplate				•	•	•		•
Other								
Media QC	•	•	•		•		•	•
Reagent QC	•	•						
Water Testing	•	•			•	•	•	
Environmental Testing	•	•			•			•
Disinfectant Efficacy Testing or Study	•	•			•	•	•	•
Internal Proficiency	•	•		•	•	•	•	•

Water Products Reference Guide

Test Methods	Qualitative QC Microorganisms		Quantitative QC Microorganisms	Certified Reference Materials		Custom Solutions
	KWIK-STIK	LYFO DISK	Epower	Epower CRM	Lab-EliteCRM	Your Strain
Presence/Absence						
Colilert®	•	•			•	
Enterolert®	•	•			•	
Fermentation (P/A) Broth	•	•			•	
Enumeration Tests						
Colilert®-18			•	•		
Enterolert® with Quantitray			•	•		
Membrane Filtration with M-Endo mFC and mEI Agar			•	•		
Heterotrophic Plate Count			•	•		
Multiple Tube Fermentation			•	•		
Pour Plate and Spread Plates			•	•		
Matrix Spikes			•	•		
Detection						
Total coliforms	•	•	•	•	•	•
Fecal coliforms	•	•	•	•	•	•
Clostridium perfringens	•	•	•	•	•	•
Escherichia coli	•	•	•	•	•	•
Enterococci	•	•	•	•	•	•
Legionella	•	•				•
Pseudomonas	•	•	•	•	•	•
Identification						
Biochemical Test Methods	•	•			•	•
Molecular Test Methods	•	•			•	•
Other						
Media QC	•	•	•	•	•	•
Reagent QC	•	•			•	
Demonstration of Capability (DOC)	•	•	•	•	•	•
Disinfectant Testing						•
Environmental Testing						•
Validation	•	•	•	•	•	•

Pharmaceutical Products Reference Guide

Test Method	Growth Promotion Test	Suitability of Counting Methods	Suitability of Sterility Tests	Suitability of Tests for Specified Microorganisms	Antimicrobial Effectiveness Test	Disinfectant Qualification	Instrument Validation	Validation of Neutralization Methods	Antibiotic Assays
EZ-Accu Shot									
No dilutions	•	•	•	•				•	
Hydrating fluid included									
50 tests per kit									
EZ-Accu Shot Select									
5 compendial strains plus <i>E. coli</i> (6 strains total)	•	•	•	•				•	
No dilutions									
Hydrating fluid included									
60 tests per kit (10 per strain)									
EZ-CFU									
One log dilution required	•	•	•	•				•	
Hydrating fluid included									
900+ tests per kit									
EZ-CFU One Step									
No dilutions	•	•	•	•				•	
Hydrating fluid included									
190 tests per kit									
EZ-PEC									
No dilutions					•				
Hydrating fluid included									
10 tests per kit									
KWIK-STIK Plus									
2 passages from reference culture	•	•	•	•	•	•	•	•	•
Easy-to-use KWIK-STIK culture									
Pack of 5 STIKs									
Epower									
Pellet concentrations from 10 ² to 10 ⁸		•				•			
Extremely versatile									
10 pellets per vial									
Custom Solutions									
Your strain, format and concentration.	•	•	•	•	•	•	•	•	•

Molds Reference Guide

Catalog Number	Product Description
01134	<i>Alternaria</i> species derived from ATCC® 20084™*
01140	<i>Aspergillus caesiellus</i> derived from ATCC® 42693™*
0392	<i>Aspergillus brasiliensis</i> derived from ATCC® 16404™*
01130	<i>Aspergillus brasiliensis</i> derived from ATCC® 9642™*
01182	<i>Aspergillus flavus</i> derived from ATCC® 9643™*
01021	<i>Aspergillus fumigatus</i> derived from ATCC® 204305™*
0500	<i>Aspergillus niger</i> derived from ATCC® 6275™*
0245	<i>Aspergillus niger</i> derived from ATCC® 16888™*
0177	<i>Aspergillus oryzae</i> derived from ATCC® 10124™*
01264	<i>Aspergillus terreus</i> derived from ATCC® 1012™*
01253	<i>Aureobasidium pullulans</i> derived from ATCC® 11942™*
01081	<i>Aureobasidium pullulans</i> var. <i>melanigenum</i> derived from ATCC® 15233™*
01094	<i>Chaetomium globosum</i> derived from ATCC® 6205™*
0537	<i>Cladosporium cladosporioides</i> derived from ATCC® 16022™*
01254	<i>Cladosporium sphaerospermum</i> derived from ATCC® 11289™*
01160	<i>Eurotium rubrum</i> derived from ATCC® 42690™*
0531	<i>Fusarium solani</i> derived from ATCC® 36031™*
0894	<i>Microsporum canis</i> derived from ATCC® 36299™*
0893	<i>Microsporum gypseum</i> derived from ATCC® 24102™*
01142	<i>Mucor racemosus</i> derived from ATCC® 42647™*
01255	<i>Mucor racemosus</i> f. <i>racemosus</i> derived from ATCC® 22365™*
0178	<i>Penicillium chrysogenum</i> derived from ATCC® 10106™*
01133	<i>Penicillium citrinum</i> derived from ATCC® 9849™*
01252	<i>Penicillium corylophilum</i> derived from ATCC® 9784™*
0207	<i>Penicillium rubens</i> derived from ATCC® 9179™*
0794	<i>Penicillium venetum</i> derived from ATCC® 16025™*
0208	<i>Rhizopus stolonifer</i> (-) derived from ATCC® 6227a™*
0209	<i>Rhizopus stolonifer</i> (+) derived from ATCC® 6227b™*
0535	<i>Talaromyces wortmannii</i> derived from ATCC® 32333™*
0442	<i>Trichophyton interdigitale</i> derived from ATCC® 9533™*
0444	<i>Trichophyton rubrum</i> derived from ATCC® 28188™*
0891	<i>Trichophyton tonsurans</i> derived from ATCC® 28942™*
01141	<i>Wallemia mellicola</i> derived from ATCC® 42694™*

microbiologics.com

In support of our commitment to quality service, we have developed our website to be a helpful, easy-to-use resource for customers. The website is updated regularly and is the best place to obtain the most current information. Listed below are examples of the resources available:

- Digital catalog
- Product descriptions and applications
- End user registration
- Certificates of Analysis and Certificates of Performance
- Online ordering
- Contact Us form
- Instructions for Use (multiple translations)
- Locate a distributor by country
- Safety Data Sheets (multiple translations)
- Customer & Technical Support documents
- Easy-to-use product and document search
- Frequently asked questions
- Order management

Customer Service

We take pride in providing you with exceptional customer service. Customer calls are answered by a team of experts ready to assist you with everything from account set up to placing an order.

All international customers should contact an authorized distributor for ordering information. Locate a distributor in your area by visiting microbiologics.com. If an authorized distributor is not listed in your country, please contact Microbiologics Customer Service.

Contact Customer Service	
Hours	7:30 a.m. - 5:00 p.m. (CST)
Phone	1.320.253.1640
USA Toll Free	1.800.599.BUGS (2847)
Fax	1.320.253.6250
Email	info@microbiologics.com

Technical Support

Our team of friendly Technical Support experts are always eager to help customers use our products successfully. They can provide guidance for selecting the right strains and product formats for your unique testing needs, and help problem solve when issues arise in your lab.

Contact Technical Support	
Hours	8:00 a.m. - 5:00 p.m. (CST)
Phone	1.320.229.7045
USA Toll Free	1.866.286.6691
Fax	1.320.253.6250
Email	techsupport@microbiologics.com

Worldwide Distribution

Our extensive distribution network allows us to reach every corner of the world, from Afghanistan to Zambia. We select distributors that are customer focused and demonstrate a commitment to our mission of providing the highest quality biomaterials for a safer, healthier world. Locate a distributor in your area by visiting microbiologics.com.

International Customers

All international customers must contact an authorized distributor within their country to place an order. To search for distributors by country, visit microbiologics.com. If an authorized distributor is not listed in your country, please contact Microbiologics Customer Service at info@microbiologics.com or +1 320.253.1640.

USA Customers

Customers located within the United States may purchase Microbiologics products directly or through an authorized distributor. Visit microbiologics.com to search for distributors in the United States. Orders can be placed online at microbiologics.com or by contacting Customer Service. Be prepared to provide the following information with your order:

- Customer account number
- Billing address
- Shipping address
- Telephone number
- Fax number
- Email address
- Purchase order number
- Quantities
- Registration number
- Credit card information
- Microbiologics catalog number(s) or reference culture number(s)
- Tax exemption information (certified exemption form must be kept on file)

Online orders can be placed at microbiologics.com by signing in on the homepage or clicking "Register" to create an account.

Product Warranty

Microbiologics guarantees results when the product is stored, handled and used as directed (as per the Expiration Date, Microbiologics Recommended Growth Requirements, Illustrated Instructions and Product Inserts). Please report concerns to Microbiologics Technical Support immediately. For more information, see the document titled Product Warranty and Product Replacement located at microbiologics.com.

Culture Methods

The selection of media, temperature, atmosphere, and growth time are all critical considerations to achieving the desired results for growing microorganisms. We provide detailed instructions for how to successfully grow the microorganism strains we produce. See the Culture Method tab on each item detail page on our website or download the *Recommended Culture Methods for Microorganisms* technical bulletin (TIB.081).

Antimicrobial Resistance Strains

Microbiologics offers a wide range of strains with characterized antimicrobial resistance mechanisms including:

- Extended-Spectrum β -lactamases (ESBLs)
- Carbapenamases
- Vancomycin-Resistant Enterococci (VRE)
- Methicillin-Resistant *Staphylococcus aureus* (MRSA)

These strains come in convenient, ready-to-use formats which are used for the quality control of laboratory developed tests, antimicrobial resistance tests and tests for toxinotypes. For more information on antimicrobial resistance strains available from Microbiologics, see the *Antimicrobial Resistance Strains document* (TIB.2025) at microbiologics.com

Mean Assay Value

The mean assay value provided on the label is the average assay value obtained by Microbiologics. Specific methods and materials are employed in determining the mean assay value. Your results may differ from the assay value listed on the product's label due to the use of different materials and methods. However, Microbiologics guarantees that if processed as directed, your results will be within the specific CFU concentration range designated for each individual product line.

End User Registration

An authorized representative from your organization must agree to the terms of the End User Agreement in order to receive Microbiologics biological materials. A royalty fee will be charged on behalf of the culture collection. Registration can be completed at microbiologics.com. Contact Customer Service at 1.320.253.1640 or info@microbiologics.com with questions about the End User Agreement.

Payment Options

Microbiologics accepts payment by the following methods:

- ACH
- Check (payable to Microbiologics, Inc.)
- Credit Card
- Money Order
- Wire Transfer

Important: To ensure your payment is processed accurately, please note your account number and the invoice number on all correspondence and payments.

Credit Card Purchases

Microbiologics welcomes the use of VISA®, MasterCard® and American Express®.

Terms

- All invoices are payable “Net 30 Days” (with the exception of credit card payments)
- Past due accounts are subject to finance charges of 1.5% per month
- All payments are paid in United States Dollars (USD)
- If not reflected on an invoice, the purchaser is responsible for all applicable State Sales and Use Taxes
- When paying by wire transfer the customer is responsible to pay all applicable transfer fees. Please email Microbiologics Customer Service at info@microbiologics.com to review options for wire transfer fee payments.

Shipping and Delivery

Orders are shipped within 48 hours unless a specific shipping date is requested. All shipments are EXW (Ex Works) Saint Cloud, Minnesota, unless prior arrangements are made. Lyophilized microorganisms are identified as Biological Substance Category B or Infectious Substance and are subject to regulated packaging materials, special labeling, and special shipping requirements. All shipping and handling charges will be listed as separate line items on the invoice.

Products are shipped at ambient temperature unless otherwise requested. The outside of the shipping container is identified with the notation “refrigerate upon receipt” to assure proper handling and storage upon arrival. Due to the nature of our products, we are unable to accept returns. If any product arrives in a damaged condition, the carrier must note the condition on the delivery receipt. All claims for products damaged during shipment must be made within 30 days of receipt. Microbiologics guarantees the performance of our products at all times. If at any time you are dissatisfied with our products or service, please contact our Customer Service team at 1.320.253.1640 or info@microbiologics.com for resolution.

Trademarks

Microbiologics® Trademarks: Epower™, Epower™ CRM, EZ-Accu Shot™, EZ-Accu Shot™ Select, EZ-SPORE™, EZ-CFU™, EZ-PEC™, KWIK-STIK™, KWIK-STIK™ Plus, Lab-Elite™, LYFO DISK™, and UV-BioTAG™ are trademarks of Microbiologics, Inc. Microbiologics® is a registered trademark of Microbiologics, Inc.



*Look for the ATCC Licensed Derivative® Emblem for all products derived from ATCC® cultures. The ATCC Licensed Derivative Emblem, the ATCC Licenses Derivative Word Mark, and the ATCC Catalog Marks are trademarks of ATCC. Microbiologics, Inc. is licensed to use these trademarks and to sell products derived from ATCC® cultures.



Simple, Reliable Qualitative QC Microorganisms



Highlights:

- Over 900 strains available
- All-in-one design reduces the risk of contamination
- Ready-to-use format saves time and money
- Refrigerated storage is easy and economical
- Online Certificate of Analysis provides detailed strain information
- Traceability to reference cultures ensures authenticity
- Technical Support experts available for guidance
- Strains are three passages or fewer from the reference culture
- FDA listed and CE Marked as an *In Vitro* Diagnostic (IVD) Medical Device

Applications:

- Culture purposes
- Daily QC
- Verification and Validation
- QC of diagnostic systems and assay kits
- QC of Antimicrobial Susceptibility Test

Package Details:

- All-in-one design including a lyophilized microorganism pellet, ampoule of hydrating fluid and inoculating swab
- Packs of two or six
- Instructions for Use
- Also available in QC Sets and Panels (each QC Set and Panel is designed to contain the QC strains recommended by the instrument manufacturer or regulatory standard)



1

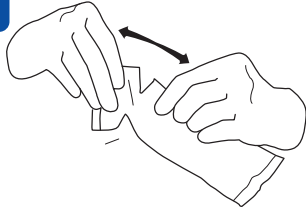

Allow the unopened KWIK-STIK™ pouch to equilibrate to room temperature. Tear open pouch at notch and remove the KWIK-STIK unit.

2

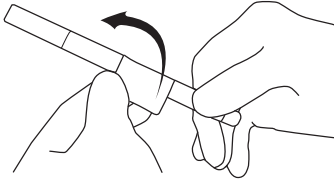

Tear off Pull-Tab portion on the label and attach it to primary culture plate or QC record. Do not disassemble the device during hydration.

3

Over the edge of the work bench or counter, crack the ampoule at the top of the KWIK-STIK (just below the fluid meniscus of the ampoule) found in the cap to release the hydrating fluid.

4

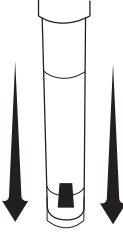

Hold vertically and tap on a hard surface to facilitate flow of fluid through shaft into bottom of unit containing pellet. Allow the hydrating fluid to flow through the swab shaft and into the bottom portion of the unit containing the pellet.

5

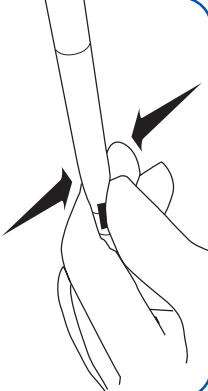

Using a pinching action on the bottom portion of the unit, crush the pellet in the fluid until the pellet suspension is homogenous.

6

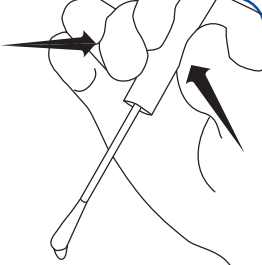

Immediately heavily saturate the swab with the hydrated material and transfer to agar medium, or use according to the laboratory's SOP.

7

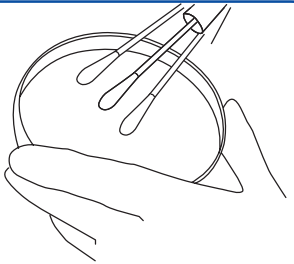

Inoculate the primary culture plate(s) by gently rolling the swab over one-third of the plate.

8

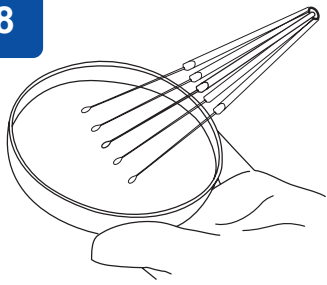

Using a sterile loop, streak to facilitate colony isolation.

9



Using proper biohazard disposal, discard the KWIK-STIK.

10

Immediately incubate the inoculated primary culture plate(s) at temperature and conditions appropriate to the microorganism.

LYFO•DISK™

Economical Qualitative QC
Microorganisms for a Variety of Culture
Purposes and QC Applications



Highlights:

- Over 900 strains available
- Easy to use – simply rehydrate the pellet and inoculate
- Convenient test ready format saves time and money
- Refrigerated storage is easy and economical
- Online Certificate of Analysis provides detailed strain information
- Traceability to reference cultures ensures authenticity
- Technical Support experts available for guidance
- Strains are three passages or fewer from the reference culture
- FDA listed and CE Marked as an *In Vitro* Diagnostic (IVD) Medical Device

Applications:

- Media and reagent QC
- QC of microbial identification including biochemical, PCR, and rapid molecular methods
- Water tests (e.g., enzyme substrates)
- Antimicrobial Susceptibility Tests
- Disinfectant studies
- Verification and Validation
- Proficiency tests

Package Details:

- Vial of 6 qualitative lyophilized microorganism pellets
- Instructions for Use



1

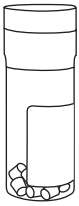

Remove the unopened LYFO DISK™ vial from 2°C to 8°C storage and allow the unopened vial to equilibrate to room temperature.

2

Aseptically remove 1 pellet with sterile forceps from the vial. Do not remove desiccant.



3

Place the pellet in 0.5 ml of sterile fluid (water, saline, TSB, or BHIB).

Immediately stopper and recap vial and return the resealed vial to 2°C to 8°C storage.

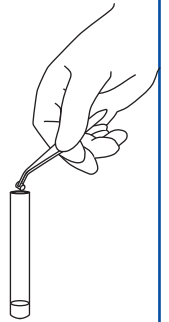

4

Crush the pellet with a sterile swab until the suspension is homogenous. Immediately heavily saturate the same swab with the hydrated material and transfer to agar medium.

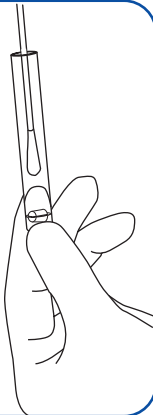

5

Inoculate the primary culture plates(s) by gently rolling the swab over one-third of the plate.

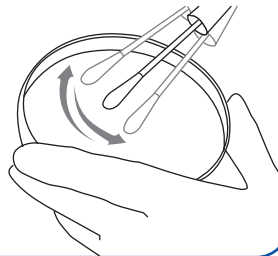

6

Using a sterile loop, streak to facilitate colony isolation.

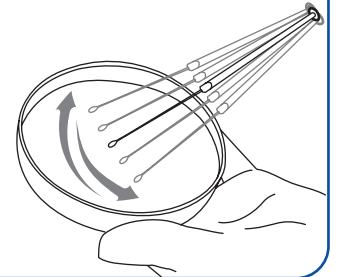

7



Using proper biohazard disposal discard the remaining hydrated material.

8

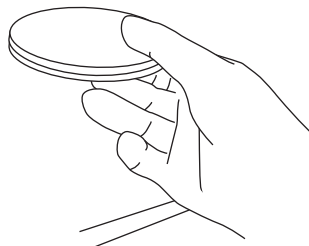

Immediately incubate the inoculated media at temperature and conditions appropriate to the microorganism.

KWIK-STIK and LYFO DISK

LYFO DISK	KWIK-STIK 6-Pack	KWIK-STIK 2-Pack	Product Description	Price Code	BSL	Comment
Acetobacter						
0511L	0511K	0511P	Acetobacter aceti derived from ATCC® 15973™*	C	1	
Achromobacter						
0516L	0516K	0516P	Achromobacter xylosoxidans derived from ATCC® 27061™*	D	2	
Acinetobacter						
0357L	0357K	0357P	Acinetobacter baumannii derived from ATCC® 19606™*	B	2	
01057L	01057K	01057P	Acinetobacter baumannii derived from ATCC® BAA-1605™*	E	2	Multi-drug resistant
0119L	0119K	0119P	Acinetobacter baumannii derived from ATCC® BAA-747™*	D	2	
0599L	0599K	0599P	Acinetobacter baumannii derived from NCIMB 12457	C	1	
01266L	01266K	01266P	Acinetobacter baumannii derived from NCTC 13304	C	2	OXA-27
0468L	0468K	0468P	Acinetobacter lwoffii derived from ATCC® 15309™*	C	2	
0973L	0973K	0973P	Acinetobacter lwoffii derived from ATCC® 17925™*	D	2	
0635L	0635K	0635P	Acinetobacter species derived from ATCC® 49139™*	C	2	
Actinobacillus						
0658L	0658K	0658P	Actinobacillus pleuropneumoniae derived from ATCC® 27088™*	D	2	
Actinomyces						
0939L	0939K	0939P	Actinomyces odontolyticus derived from ATCC® 17929™*	D	2	
0750L	0750K	0750P	Actinomyces viscosus derived from ATCC® 15987™*	D	2	
Aerococcus						
0263L	0263K	0263P	Aerococcus viridans derived from ATCC® 10400™*	C	1	
0276L	0276K	0276P	Aerococcus viridans derived from ATCC® 11563™*	C	1	
0746L	0746K	0746P	Aerococcus viridans derived from ATCC® 700406™*	D	1	
Aeromonas						
0910L	0910K	0910P	Aeromonas hydrophila derived from ATCC® 35654™*	C	2	
0637L	0637K	0637P	Aeromonas hydrophila derived from ATCC® 49140™*	C	2	
0870L	0870K	0870P	Aeromonas hydrophila derived from ATCC® 7966™*	C	2	
0290L	0290K	0290P	Aeromonas salmonicida derived from ATCC® 7965™*	C	2	Formerly Aeromonas hydrophila
Aggregatibacter						
01175L	01175K	01175P	Aggregatibacter actinomycetemcomitans (b) derived from ATCC® 29522™*	D	2	Serotype b
0467L	0467K	0467P	Aggregatibacter aphrophilus derived from ATCC® 29241™*	E	2	V-dependant; Formerly Haemophilus paraphrophilus
0184L	0184K	0184P	Aggregatibacter aphrophilus derived from ATCC® 33389™*	D	1	
0645L	0645K	0645P	Aggregatibacter aphrophilus derived from ATCC® 49146™*	D	2	Formerly Haemophilus paraphrophilus



*Look for the ATCC Licensed Derivative® Emblem for all products derived from ATCC® cultures. The ATCC Licensed Derivative Emblem, the ATCC Licenses Derivative Word Mark, and the ATCC Catalog Marks are trademarks of ATCC. Microbiology, Inc. is licensed to use these trademarks and to sell products derived from ATCC® cultures.

KWIK-STIK and LYFO DISK

LYFO DISK	KWIK-STIK 6-Pack	KWIK-STIK 2-Pack	Product Description	Price Code	BSL	Comment
0249L	0249K	0249P	Aggregatibacter aphrophilus derived from ATCC® 49917™*	D	2	Formerly Haemophilus paraphrophilus
0411L	0411K	0411P	Aggregatibacter aphrophilus derived from ATCC® 7901™*	C	2	Formerly Haemophilus parainfluenzae
Alcaligenes						
0911L	0911K	0911P	Alcaligenes faecalis subsp. faecalis derived from ATCC® 35655™*	C	1	
0402L	0402K	0402P	Alcaligenes faecalis subsp. faecalis derived from ATCC® 8750™*	C	1	
Alicyclobacillus						
01059L	01059K	01059P	Alicyclobacillus acidocaldarius subsp. acidocaldarius derived from NCIMB 11725	D	1	
0265L	0265K	0265P	Alicyclobacillus acidoterrestris derived from ATCC® 49025™*	E	1	
Alternaria						
01134L	01134K	01134P	Alternaria species derived from ATCC® 20084™*	D	1	Mold
Aneurinibacillus						
0141L	0141K	0141P	Aneurinibacillus aneurinilyticus derived from ATCC® 11376™*	C	1	Formerly Aneurinibacillus aneurinolyticus
Arcanobacterium						
01038L	01038K	01038P	Arcanobacterium haemolyticum derived from ATCC® BAA-1784™*	D	2	
Arthrobacter						
0260L	0260K	0260P	Arthrobacter psychrolactophilus derived from ATCC® 700733™*	E	1	Psychrotroph
Aspergillus						
0392L	0392K	0392P	Aspergillus brasiliensis derived from ATCC® 16404™*	E	1	Mold
01130L	01130K	01130P	Aspergillus brasiliensis derived from ATCC® 9642™*	E	1	Mold
01140L	01140K	01140P	Aspergillus caesiellus derived from ATCC® 42693™*	E	1	Mold
01182L	01182K	01182P	Aspergillus flavus derived from ATCC® 9643™*	E	1	Mold
01021L	01021K	01021P	Aspergillus fumigatus derived from ATCC® 204305™*	E	2	Mold
0245L	0245K	0245P	Aspergillus niger derived from ATCC® 16888™*	E	1	Mold
0500L	0500K	0500P	Aspergillus niger derived from ATCC® 6275™*	E	1	Mold
0177L	0177K	0177P	Aspergillus oryzae derived from ATCC® 10124™*	E	1	Mold
01264L	01264K	01264P	Aspergillus terreus derived from ATCC® 1012™*	D	1	
Aureobasidium						
01253L	01253K	01253P	Aureobasidium pullulans derived from ATCC® 11942™*	E	1	Mold
01081L	01081K	01081P	Aureobasidium pullulans var. melanigenum derived from ATCC® 15233™*	E	1	Mold
Bacillus						
0953L	0953K	0953P	Bacillus atrophaeus derived from ATCC® 9372™*	B	1	



*Look for the ATCC Licensed Derivative® Emblem for all products derived from ATCC® cultures. The ATCC Licensed Derivative Emblem, the ATCC Licenses Derivative Word Mark, and the ATCC Catalog Marks are trademarks of ATCC. Microbiology, Inc. is licensed to use these trademarks and to sell products derived from ATCC® cultures.

KWIK-STIK and LYFO DISK

LYFO DISK	KWIK-STIK 6-Pack	KWIK-STIK 2-Pack	Product Description	Price Code	BSL	Comment
01008L	01008K	01008P	Bacillus badius derived from ATCC® 14574™*	B	1	
0998L	0998K	0998P	Bacillus cereus derived from ATCC® 10876™*	B	1	
0256L	0256K	0256P	Bacillus cereus derived from ATCC® 11778™*	C	1	
0999L	0999K	0999P	Bacillus cereus derived from ATCC® 13061™*	B	1	
0200L	0200K	0200P	Bacillus cereus derived from ATCC® 14579™*	D	1	
0198L	0198K	0198P	Bacillus cereus derived from ATCC® 33019™*	E	2	
0330L	0330K	0330P	Bacillus cereus derived from NCIMB 7464	B	2	
0507L	0507K	0507P	Bacillus circulans derived from ATCC® 4516™*	E	1	
0140L	0140K	0140P	Bacillus circulans derived from ATCC® 61™*	C	1	
0596L	0596K	0596P	Bacillus coagulans derived from ATCC® 7050™*	C	1	
0812L	0812K	0812P	Bacillus licheniformis derived from ATCC® 12759™*	B	1	
0799L	0799K	0799P	Bacillus licheniformis derived from ATCC® 14580™*	D	1	
0201L	0201K	0201P	Bacillus megaterium derived from ATCC® 14581™*	C	1	
0116L	0116K	0116P	Bacillus megaterium derived from ATCC® 9885™*	C	1	
0258L	0258K	0258P	Bacillus pumilus derived from ATCC® 14884™*	C	1	
0577L	0577K	0577P	Bacillus pumilus derived from ATCC® 700814™*	D	1	
0474L	0474K	0474P	Bacillus pumilus derived from ATCC® BAA-1434™*	C	1	
0269L	0269K	0269P	Bacillus subtilis derived from ATCC® 11774™*	C	1	
0540L	0540K	0540P	Bacillus subtilis derived from ATCC® 19659™*	C	1	
0486L	0486K	0486P	Bacillus subtilis subsp. spizizenii derived from ATCC® 6633™*	B	1	
0120L	0120K	0120P	Bacillus subtilis subsp. subtilis derived from ATCC® 6051™*	C	1	
0270L	0270K	0270P	Bacillus thuringiensis derived from ATCC® 10792™*	C	1	
0539L	0539K	0539P	Bacillus thuringiensis derived from ATCC® 33679™*	D	1	Serotype H3:3a,3b
Bacteroides						
0940L	0940K	0940P	Bacteroides fragilis derived from ATCC® 23745™*	D	2	
0320L	0320K	0320P	Bacteroides fragilis derived from ATCC® 25285™*	D	2	Beta-lactamase positive; CLSI QC strain for Anaerobic Antimicrobial Susceptibility Testing
0358L	0358K	0358P	Bacteroides fragilis derived from NCTC 9343	D	2	
0400L	0400K	0400P	Bacteroides ovatus derived from ATCC® 8483™*	D	2	
0585L	0585K	0585P	Bacteroides ovatus derived from ATCC® BAA-1296™*	D	2	
0587L	0587K	0587P	Bacteroides ovatus derived from ATCC® BAA-1304™*	D	2	
0319L	0319K	0319P	Bacteroides thetaiotaomicron derived from ATCC® 29741™*	D	2	Beta-lactamase positive; CLSI QC strain for Anaerobic Antimicrobial Susceptibility Testing



*Look for the ATCC Licensed Derivative® Emblem for all products derived from ATCC® cultures. The ATCC Licensed Derivative Emblem, the ATCC Licenses Derivative Word Mark, and the ATCC Catalog Marks are trademarks of ATCC. Microbiology, Inc. is licensed to use these trademarks and to sell products derived from ATCC® cultures.

KWIK-STIK and LYFO DISK

LYFO DISK	KWIK-STIK 6-Pack	KWIK-STIK 2-Pack	Product Description	Price Code	BSL	Comment
0619L	0619K	0619P	Bacteroides uniformis derived from ATCC® 8492™*	D	2	
0445L	0445K	0445P	Bacteroides vulgatus derived from ATCC® 8482™*	D	2	
Bifidobacterium						
01092L	01092K	01092P	Bifidobacterium animalis subsp. animalis derived from ATCC® 25527™*	E	1	
01025L	01025K	01025P	Bifidobacterium bifidum derived from ATCC® 11863™*	E	1	
0175L	0175K	0175P	Bifidobacterium breve derived from ATCC® 15700™*	D	1	
Bordetella						
0655L	0655K	0655P	Bordetella bronchiseptica derived from ATCC® 10580™*	D	2	
0671L	0671K	0671P	Bordetella bronchiseptica derived from ATCC® 4617™*	D	2	
0842L	0842K	0842P	Bordetella parapertussis derived from ATCC® 15311™*	D	2	
0489L	0489K	0489P	Bordetella pertussis derived from ATCC® 8467™*	D	2	
0843L	0843K	0843P	Bordetella pertussis derived from ATCC® 9797™*	D	2	
Brevibacillus						
0139L	0139K	0139P	Brevibacillus agri derived from ATCC® 51663™*	C	1	
0144L	0144K	0144P	Brevibacillus laterosporus derived from ATCC® 64™*	C	1	
Brevundimonas						
0754L	0754K	0754P	Brevundimonas diminuta derived from ATCC® 11568™*	B	1	
0805L	0805K	0805P	Brevundimonas diminuta derived from ATCC® 19146™*	D	1	
01167L	01167K	01167P	Brevundimonas vesicularis derived from ATCC® 11426™*	D	1	
Brochothrix						
0150L	0150K	0150P	Brochothrix thermosphacta derived from ATCC® 11509™*	D	1	
Burkholderia						
01269L	01269K	01269P	Burkholderia cenocepacia derived from ATCC® BAA-245™*	C	2	
0488L	0488K	0488P	Burkholderia cepacia derived from ATCC® 25416™*	C	2	
0836L	0836K	0836P	Burkholderia cepacia derived from ATCC® 25608™*	C	2	
01270L	01270K	01270P	Burkholderia multivorans derived from ATCC® BAA-247™*	C	2	
Campylobacter						
01023L	01023K	01023P	Campylobacter coli derived from ATCC® 33559™*	E	2	
0121L	0121K	0121P	Campylobacter coli derived from ATCC® 43478™*	E	2	
01237L	01237K	01237P	Campylobacter fetus subsp. fetus derived from ATCC® 27374™*	D	2	Quality Control Strain for FDA Bacteriological Analytical Manual
0325L	0325K	0325P	Campylobacter jejuni subsp. jejuni derived from ATCC® 29428™*	E	2	



*Look for the ATCC Licensed Derivative® Emblem for all products derived from ATCC® cultures. The ATCC Licensed Derivative Emblem, the ATCC Licenses Derivative Word Mark, and the ATCC Catalog Marks are trademarks of ATCC. Microbiologics, Inc. is licensed to use these trademarks and to sell products derived from ATCC® cultures.

KWIK-STIK and LYFO DISK

LYFO DISK	KWIK-STIK 6-Pack	KWIK-STIK 2-Pack	Product Description	Price Code	BSL	Comment
0481L	0481K	0481P	Campylobacter jejuni subsp. jejuni derived from ATCC® 33291™*	E	2	
0111L	0111K	0111P	Campylobacter jejuni subsp. jejuni derived from ATCC® 33560™*	E	2	EUCAST QC strain for Disk Diffusion and MIC determination
0525L	0525K	0525P	Campylobacter jejuni subsp. jejuni derived from ATCC® 43430™*	E	2	Serotype O:2
0251L	0251K	0251P	Campylobacter jejuni subsp. jejuni derived from ATCC® 49943™*	E	2	
0188L	0188K	0188P	Campylobacter jejuni subsp. jejuni derived from ATCC® BAA-1153™*	E	2	
0718L	0718K	0718P	Campylobacter jejuni subsp. jejuni derived from NCTC 11322	E	2	
0712L	0712K	0712P	Campylobacter jejuni subsp. jejuni derived from NCTC 13367	E	2	
01132L	01132K	01132P	Campylobacter lari derived from ATCC® 35221™*	E	1	
Candida						
0443L	0443K	0443P	Candida albicans derived from ATCC® 10231™*	D	1	Yeast cells
0332L	0332K	0332P	Candida albicans derived from ATCC® 14053™*	D	1	Yeast cells
0896L	0896K	0896P	Candida albicans derived from ATCC® 2091™*	D	1	Yeast cells
0800L	0800K	0800P	Candida albicans derived from ATCC® 24433™*	D	1	Yeast cells
0425L	0425K	0425P	Candida albicans derived from ATCC® 60193™*	D	1	Yeast cells
0981L	0981K	0981P	Candida albicans derived from ATCC® 66027™*	D	1	Yeast cells
0264L	0264K	0264P	Candida albicans derived from ATCC® 90028™*	D	1	CLSI QC strain for Antimicrobial Susceptibility Testing using the Disk Diffusion Method; yeast cells
0250L	0250K	0250P	Candida albicans derived from ATCC® 90029™*	D	1	Yeast cells
0379L	0379K	0379P	Candida albicans derived from NCYC 1363	D	1	Yeast cells
01256L	01256K	01256P	Candida auris derived from CDC B11903	E	2	Yeast cells
01139L	01139K	01139P	Candida dubliniensis derived from NCPF 3949	D	1	Yeast cells
0520L	0520K	0520P	Candida geochares derived from ATCC® 36852™*	D	1	Yeast cells
0737L	0737K	0737P	Candida glabrata derived from ATCC® 15126™*	D	1	Yeast cells
0992L	0992K	0992P	Candida glabrata derived from ATCC® 2001™*	D	1	Yeast cells
0986L	0986K	0986P	Candida glabrata derived from ATCC® 66032™*	D	1	Yeast cells
0122L	0122K	0122P	Candida glabrata derived from ATCC® MYA-2950™*	E	1	Yeast cells
0990L	0990K	0990P	Candida kefyr derived from ATCC® 2512™*	D	1	Yeast cells
0982L	0982K	0982P	Candida kefyr derived from ATCC® 66028™*	D	1	Yeast cells
01185L	01185K	01185P	Candida kefyr derived from ATCC® 8553™*	D	1	Yeast cells
0809L	0809K	0809P	Candida krusei derived from ATCC® 14243™*	D	1	Yeast cells
0510L	0510K	0510P	Candida krusei derived from ATCC® 34135™*	E	1	Yeast cells



*Look for the ATCC Licensed Derivative® Emblem for all products derived from ATCC® cultures. The ATCC Licensed Derivative Emblem, the ATCC Licenses Derivative Word Mark, and the ATCC Catalog Marks are trademarks of ATCC. Microbiology, Inc. is licensed to use these trademarks and to sell products derived from ATCC® cultures.

KWIK-STIK and LYFO DISK

LYFO DISK	KWIK-STIK 6-Pack	KWIK-STIK 2-Pack	Product Description	Price Code	BSL	Comment
0774L	0774K	0774P	Candida lusitanae derived from ATCC® 34449™*	D	1	Yeast cells
0726L	0726K	0726P	Candida parapsilosis derived from ATCC® 22019™*	D	1	CLSI QC strain for Disk Diffusion and MIC determination; yeast cells
01036L	01036K	01036P	Candida tropicalis derived from ATCC® 1369™*	E	1	Yeast cells
0450L	0450K	0450P	Candida tropicalis derived from ATCC® 13803™*	D	1	Yeast cells
0983L	0983K	0983P	Candida tropicalis derived from ATCC® 66029™*	D	1	Yeast cells
0847L	0847K	0847P	Candida tropicalis derived from ATCC® 750™*	D	1	CLSI QC strain for Disk Diffusion; yeast cells
0897L	0897K	0897P	Candida tropicalis derived from ATCC® 9968™*	D	1	Yeast cells
0779L	0779K	0779P	Candida utilis derived from ATCC® 9950™*	D	1	Yeast cells
Capnocytophaga						
0749L	0749K	0749P	Capnocytophaga sputigena derived from ATCC® 33612™*	C	2	
Cedecea						
0517L	0517K	0517P	Cedecea neteri derived from ATCC® 33855™*	E	2	
Cellulosimicrobium						
01046L	01046K	01046P	Cellulosimicrobium cellulans derived from ATCC® BAA-1816™*	D	1	
01047L	01047K	01047P	Cellulosimicrobium cellulans derived from ATCC® BAA-1817™*	D	1	
0294L	0294K	0294P	Cellulosimicrobium cellulans derived from ATCC® 27402™*	D	1	
Chaetomium						
01094L	01094K	01094P	Chaetomium globosum derived from ATCC® 6205™*	E	1	Mold
Chryseobacterium						
01186L	01186K	01186P	Chryseobacterium indologenes derived from ATCC® 29897™*	E	2	
0164L	0164K	0164P	Chryseobacterium shigense derived from ATCC® 51823™*	E	1	
Citrobacter						
0478L	0478K	0478P	Citrobacter braakii derived from ATCC® 43162™*	C	1	
0578L	0578K	0578P	Citrobacter braakii derived from ATCC® 51113™*	D	1	
0229L	0229K	0229P	Citrobacter freundii derived from ATCC® 43864™*	B	1	
0315L	0315K	0315P	Citrobacter freundii derived from ATCC® 8090™*	C	1	
01169L	01169K	01169P	Citrobacter freundii derived from ATCC® 8454™*	C	1	
0574L	0574K	0574P	Citrobacter freundii derived from NCTC 9750	C	1	
0106L	0106K	0106P	Citrobacter koseri derived from ATCC® 27156™*	E	1	
Cladosporium						
0537L	0537K	0537P	Cladosporium cladosporioides derived from ATCC® 16022™*	E	1	Mold



*Look for the ATCC Licensed Derivative® Emblem for all products derived from ATCC® cultures. The ATCC Licensed Derivative Emblem, the ATCC Licenses Derivative Word Mark, and the ATCC Catalog Marks are trademarks of ATCC. Microbiology, Inc. is licensed to use these trademarks and to sell products derived from ATCC® cultures.

KWIK-STIK and LYFO DISK

LYFO DISK	KWIK-STIK 6-Pack	KWIK-STIK 2-Pack	Product Description	Price Code	BSL	Comment
01254L	01254K	01254P	Cladosporium sphaerospermum derived from ATCC® 11289™*	E	1	Mold
Clostridioides						
0329L	0329K	0329P	Clostridioides difficile derived from ATCC® 9689™*	D	2	Genotype: tcdA positive, tcdB positive; cdtB negative; Toxinotype 0; Ribotype 001; Produces cytotoxin
01206L	01206K	01206P	Clostridioides difficile derived from ATCC® 43255™*	D	2	Formerly Clostridium difficile; tcdA positive, tcdB positive; Toxinotype 0; Ribotype 087
0833L	0833K	0833P	Clostridioides difficile derived from ATCC® 43593™*	D	2	Formerly Clostridium difficile; Genotype: tcdA negative, tcdB negative; cdtB negative; Toxin A and B negative; Ribotype: 060; Serogroup B
0527L	0527K	0527P	Clostridioides difficile derived from ATCC® 700057™*	D	2	Formerly Clostridium difficile; Beta-lactamase positive; nontoxigenic; CLSI QC strain for Anaerobic Antimicrobial Susceptibility Testing; Genotype: tcdA negative, tcdB negative; cdtB negative; Ribotype 038
01048L	01048K	01048P	Clostridioides difficile derived from ATCC® BAA-1870™*	D	2	Formerly Clostridium difficile; Genotype: tcdA positive, tcdB positive; tcdA positive, tcdB positive; cdtB positive; Binary Toxin positive; Toxinotype IIIb; Ribotype 027; PFGE Type NAP1; REA type BI 8
01161L	01161K	01161P	Clostridioides difficile derived from CDC 20110736	D	2	Formerly Clostridium difficile; Genotype: tcdA negative, tcdB negative, tcdC _deletion negative; cdtA negative, cdtB negative PFGE Type: Unnamed Isolation: NY 2011
01162L	01162K	01162P	Clostridioides difficile derived from CDC 20110995	D	2	Formerly Clostridium difficile; Genotype: tcdA positive, tcdB positive, tcdC _deletion 0 bp; cdtA negative, cdtB negative PFGE Type: NAP11 Isolation: MN 2011
01163L	01163K	01163P	Clostridioides difficile derived from CDC 20120296	D	2	Formerly Clostridium difficile; Genotype: tcdA positive, tcdB positive, tcdC _deletion 39 bp; cdtA positive, cdtB positive PFGE Type: NAP8 Isolation: GA 2011
01164L	01164K	01164P	Clostridioides difficile derived from CDC 20120905	D	2	Formerly Clostridium difficile; Genotype: tcdA positive, tcdB positive, tcdC _deletion 0 bp; cdtA negative, cdtB negative; PFGE; Isolation: MN 2011



*Look for the ATCC Licensed Derivative® Emblem for all products derived from ATCC® cultures. The ATCC Licensed Derivative Emblem, the ATCC Licenses Derivative Word Mark, and the ATCC Catalog Marks are trademarks of ATCC. Microbiology, Inc. is licensed to use these trademarks and to sell products derived from ATCC® cultures.

KWIK-STIK and LYFO DISK

LYFO DISK	KWIK-STIK 6-Pack	KWIK-STIK 2-Pack	Product Description	Price Code	BSL	Comment
01165L	01165K	01165P	Clostridioides difficile derived from CDC 20121308	D	2	Formerly Clostridium difficile; Genotype: tcdA positive, tcdB positive, tcdC_deletion 18 bp; cdtA positive, cdtB positive PFGE Type: NAP1 Isolation: NY 2011
01166L	01166K	01166P	Clostridioides difficile derived from CDC 20131122	D	2	Formerly Clostridium difficile; Genotype: tcdA positive, tcdB positive, tcdC_deletion 39 bp; cdtA positive, cdtB positive PFGE Type: NAP7 Isolation: CO 2011
Clostridium						
0828L	0828K	0828P	Clostridium bifermentans derived from ATCC® 638™*	D	1	
01196L	01196K	01196P	Clostridium bifermentans derived from NCTC 506	D	2	
0327L	0327K	0327P	Clostridium histolyticum derived from ATCC® 19401™*	D	2	
0801L	0801K	0801P	Clostridium perfringens derived from ATCC® 12915™*	E	2	
0123L	0123K	0123P	Clostridium perfringens derived from ATCC® 12916™*	D	2	
0674L	0674K	0674P	Clostridium perfringens derived from ATCC® 12919™*	D	2	Export license required for shipping outside the U.S.
0318L	0318K	0318P	Clostridium perfringens derived from ATCC® 13124™*	D	2	
0257L	0257K	0257P	Clostridium perfringens derived from ATCC® 3624™*	D	2	
0572L	0572K	0572P	Clostridium perfringens derived from NCTC 8237	D	2	Type A
0547L	0547K	0547P	Clostridium perfringens derived from NCTC 8678	D	2	Non-epsilon toxin producing; heat resistant
0586L	0586K	0586P	Clostridium septicum derived from ATCC® 12464™*	D	2	
0331L	0331K	0331P	Clostridium sordellii derived from ATCC® 9714™*	D	2	
0487L	0487K	0487P	Clostridium sporogenes derived from ATCC® 11437™*	D	1	
0317L	0317K	0317P	Clostridium sporogenes derived from ATCC® 19404™*	D	1	
0676L	0676K	0676P	Clostridium sporogenes derived from ATCC® 3584™*	D	1	
01188L	01188K	01188P	Clostridium sporogenes derived from ATCC® 9690™*	D	2	
0580L	0580K	0580P	Clostridium sporogenes derived from NCIMB 12343	D	1	
Corynebacterium						
0844L	0844K	0844P	Corynebacterium diphtheriae derived from ATCC® 13812™*	D	2	
01108L	01108K	01108P	Corynebacterium jeikeium derived from ATCC® 43734™*	D	2	
0965L	0965K	0965P	Corynebacterium pseudodiphtheriticum derived from ATCC® 10700™*	D	1	
0884L	0884K	0884P	Corynebacterium pseudodiphtheriticum derived from ATCC® 10701™*	D	1	
0293L	0293K	0293P	Corynebacterium renale derived from ATCC® 19412™*	D	2	
01040L	01040K	01040P	Corynebacterium renale derived from ATCC® BAA-1785™*	D	2	



*Look for the ATCC Licensed Derivative® Emblem for all products derived from ATCC® cultures. The ATCC Licensed Derivative Emblem, the ATCC Licenses Derivative Word Mark, and the ATCC Catalog Marks are trademarks of ATCC. Microbiology, Inc. is licensed to use these trademarks and to sell products derived from ATCC® cultures.

KWIK-STIK and LYFO DISK

LYFO DISK	KWIK-STIK 6-Pack	KWIK-STIK 2-Pack	Product Description	Price Code	BSL	Comment
0583L	0583K	0583P	Corynebacterium striatum derived from ATCC® BAA-1293™*	D	1	
01039L	01039K	01039P	Corynebacterium urealyticum derived from ATCC® 43044™*	D	2	
0153L	0153K	0153P	Corynebacterium xerosis derived from ATCC® 373™*	D	1	
Cronobacter						
0756L	0756K	0756P	Cronobacter muytjensii derived from ATCC® 51329™*	D	1	
01088L	01088K	01088P	Cronobacter sakazakii derived from ATCC® 29544™*	E	1	
Cryptococcus						
0984L	0984K	0984P	Cryptococcus albidus derived from ATCC® 66030™*	D	2	Yeast cells
01051L	01051K	01051P	Cryptococcus gattii derived from ATCC® MYA-4560™*	E	2	Yeast cells
0333L	0333K	0333P	Cryptococcus laurentii derived from ATCC® 18803™*	D	1	Yeast cells
0991L	0991K	0991P	Cryptococcus laurentii derived from ATCC® 66036™*	D	2	Yeast cells
0451L	0451K	0451P	Cryptococcus liquefaciens derived from ATCC® 34140™*	D	2	Formerly Cryptococcus albidus; yeast cells
01173L	01173K	01173P	Cryptococcus neoformans (D) derived from ATCC® 36556™*	D	2	Serotype D
01172L	01172K	01172P	Cryptococcus neoformans derived from ATCC® 13690™*	D	2	Yeast cells
0291L	0291K	0291P	Cryptococcus neoformans derived from ATCC® 14116™*	D	2	Yeast cells
0781L	0781K	0781P	Cryptococcus neoformans derived from ATCC® 204092™*	D	2	Yeast cells
0334L	0334K	0334P	Cryptococcus neoformans derived from ATCC® 32045™*	D	2	Yeast cells
01063L	01063K	01063P	Cryptococcus neoformans derived from ATCC® 34877™*	D	2	Serotype B; yeast cells
0985L	0985K	0985P	Cryptococcus neoformans derived from ATCC® 66031™*	D	2	Yeast cells
0987L	0987K	0987P	Cryptococcus uniguttulatus derived from ATCC® 66033™*	D	2	Yeast cells
Curtobacterium						
01044L	01044K	01044P	Curtobacterium pusillum derived from ATCC® 19096™*	D	1	
Cutibacterium						
0170L	0170K	0170P	Cutibacterium acnes derived from ATCC® 6919™*	E	1	
0419L	0419K	0419P	Cutibacterium acnes derived from ATCC® 11827™*	D	1	
Deinococcus						
01184L	01184K	01184P	Deinococcus radiophilus derived from ATCC® 27603™*	E	1	
Desulfotomaculum						
01026L	01026K	01026P	Desulfotomaculum nigrificans derived from ATCC® 7946™*	E	1	
Edwardsiella						
0845L	0845K	0845P	Edwardsiella tarda derived from ATCC® 15947™*	C	2	



*Look for the ATCC Licensed Derivative® Emblem for all products derived from ATCC® cultures. The ATCC Licensed Derivative Emblem, the ATCC Licenses Derivative Word Mark, and the ATCC Catalog Marks are trademarks of ATCC. Microbiology, Inc. is licensed to use these trademarks and to sell products derived from ATCC® cultures.

KWIK-STIK and LYFO DISK

LYFO DISK	KWIK-STIK 6-Pack	KWIK-STIK 2-Pack	Product Description	Price Code	BSL	Comment
Eggerthella						
0936L	0936K	0936P	Eggerthella lenta derived from ATCC® 43055™*	D	1	CLSI QC strain for Anaerobic Antimicrobial Susceptibility Testing
Eikenella						
0189L	0189K	0189P	Eikenella corrodens derived from ATCC® BAA-1152™*	C	2	
Elizabethkingia						
0971L	0971K	0971P	Elizabethkingia meningoseptica derived from ATCC® 13253™*	C	2	
Enterobacter						
01202L	01202K	01202P	Enterobacter cloacae derived from ATCC® BAA-2341™*	C	2	blaKPC positive; produces carbapenemase KPC; carbapenem-resistant (Imipenem and Ertapenem)
01111L	01111K	01111P	Enterobacter cloacae derived from NCTC 13406	D	2	Control for AmpC detection tests
01105L	01105K	01105P	Enterobacter cloacae derived from NCTC 13464	D	2	blaCTX-M group 9 gene; CTX-M extended-spectrum (beta)-lactamases
0323L	0323K	0323P	Enterobacter cloacae subsp. cloacae derived from ATCC® 13047™*	B	1	
0313L	0313K	0313P	Enterobacter cloacae subsp. cloacae derived from ATCC® 23355™*	B	1	
0388L	0388K	0388P	Enterobacter cloacae subsp. cloacae derived from ATCC® 35030™*	B	1	
0639L	0639K	0639P	Enterobacter cloacae subsp. cloacae derived from ATCC® 49141™*	C	1	
01018L	01018K	01018P	Enterobacter cloacae subsp. cloacae derived from ATCC® BAA-1143™*	D	2	High level producer of chromosomal Amp C beta-lactamase; strong positive control strain for the AmpC disk test
0755L	0755K	0755P	Enterobacter hormaechei derived from ATCC® 700323™*	C	1	Formerly Enterobacter cloacae subsp. cloacae
Enterococcus						
0761L	0761K	0761P	Enterococcus casseliflavus derived from ATCC® 700327™*	B	1	
0623L	0623K	0623P	Enterococcus durans derived from ATCC® 11576™*	C	1	
0651L	0651K	0651P	Enterococcus durans derived from ATCC® 6056™*	C	1	
0181L	0181K	0181P	Enterococcus faecalis derived from ATCC® 14506™*	C	2	
0367L	0367K	0367P	Enterococcus faecalis derived from ATCC® 19433™*	C	2	
0366L	0366K	0366P	Enterococcus faecalis derived from ATCC® 29212™*	C	2	EUCAST QC strain for Disk Diffusion; CLSI and EUCAST QC strain for MIC Determination
0197L	0197K	0197P	Enterococcus faecalis derived from ATCC® 33186™*	D	2	



*Look for the ATCC Licensed Derivative® Emblem for all products derived from ATCC® cultures. The ATCC Licensed Derivative Emblem, the ATCC Licenses Derivative Word Mark, and the ATCC Catalog Marks are trademarks of ATCC. Microbiologics, Inc. is licensed to use these trademarks and to sell products derived from ATCC® cultures.

KWIK-STIK and LYFO DISK

LYFO DISK	KWIK-STIK 6-Pack	KWIK-STIK 2-Pack	Product Description	Price Code	BSL	Comment
0753L	0753K	0753P	Enterococcus faecalis derived from ATCC® 49532™*	E	2	High level Gentamicin-resistant and Streptomycin-sensitive
0752L	0752K	0752P	Enterococcus faecalis derived from ATCC® 49533™*	C	2	High level Gentamicin-resistant and Streptomycin-sensitive
0959L	0959K	0959P	Enterococcus faecalis derived from ATCC® 51299™*	C	2	vanB positive; Low level vancomycin resistant; resistant to high level aminoglycosides (gentamicin and streptomycin); Sensitive to teichoplanin; ant(6)-1 aac(6') aph(2''); control for antimicrobial susceptibility testing
01089L	01089K	01089P	Enterococcus faecalis derived from ATCC® 51575™*	E	2	Resistant to gentamicin, streptomycin and vancomycin; vanB positive
0497L	0497K	0497P	Enterococcus faecalis derived from ATCC® 7080™*	C	2	
0336L	0336K	0336P	Enterococcus faecalis derived from NCIMB 13280	C	2	
0714L	0714K	0714P	Enterococcus faecalis derived from NCTC 13379	E	2	
0472L	0472K	0472P	Enterococcus faecalis derived from NCTC 775	C	2	
01052L	01052K	01052P	Enterococcus faecium derived from ATCC® 6057™*	E	2	
0677L	0677K	0677P	Enterococcus faecium derived from ATCC® 6569™*	D	2	
01260L	01260K	01260P	Enterococcus faecium derived from ATCC® 8459™*	D	1	Used as a surrogate microorganism in the pasteurization of nuts
0679L	0679K	0679P	Enterococcus faecium derived from ATCC® 27270™*	D	2	
0968L	0968K	0968P	Enterococcus faecium derived from ATCC® 35667™*	C	2	
01000L	01000K	01000P	Enterococcus faecium derived from ATCC® 700221™*	C	2	vanA positive; IS16 and esp positive; resistant to vancomycin and teicoplanin
01143L	01143K	01143P	Enterococcus faecium derived from NCTC 12204	C	2	vanA-type glycopeptide resistance; vancomycin resistant
0895L	0895K	0895P	Enterococcus gallinarum derived from ATCC® 49573™*	C	1	
0678L	0678K	0678P	Enterococcus hirae derived from ATCC® 10541™*	D	1	
0650L	0650K	0650P	Enterococcus hirae derived from ATCC® 8043™*	C	1	
0857L	0857K	0857P	Enterococcus raffinosus derived from ATCC® 49464™*	C	1	
0223L	0223K	0223P	Enterococcus saccharolyticus derived from ATCC® 43076™*	C	1	
Erysipelothrix						
0661L	0661K	0661P	Erysipelothrix rhusiopathiae derived from ATCC® 19414™*	C	2	
Escherichia						
0204L	0204K	0204P	Escherichia coli (JM101) derived from ATCC® 33876™*	C	1	



*Look for the ATCC Licensed Derivative® Emblem for all products derived from ATCC® cultures. The ATCC Licensed Derivative Emblem, the ATCC Licenses Derivative Word Mark, and the ATCC Catalog Marks are trademarks of ATCC. Microbiology, Inc. is licensed to use these trademarks and to sell products derived from ATCC® cultures.

KWIK-STIK and LYFO DISK

LYFO DISK	KWIK-STIK 6-Pack	KWIK-STIK 2-Pack	Product Description	Price Code	BSL	Comment
01101L	01101K	01101P	Escherichia coli (O103:H11) derived from CDC 06-3008	F	2	Serotype O103:H11; eae positive; stx 1 and/or stx 2 positive; export license required for shipping outside the U.S.
01104L	01104K	01104P	Escherichia coli (O104:H4) derived from ATCC® BAA-2326™*	F	2	Serotype O104:H4; aggR positive; stx 2 positive; export license required for shipping outside the U.S.
01102L	01102K	01102P	Escherichia coli (O111:H8) derived from CDC 2010C-3114	F	2	Serotype O111:H8; eae positive; stx 1 and/or stx 2 positive; export license required for shipping outside the U.S.
01099L	01099K	01099P	Escherichia coli (O121:H19) derived from CDC 02-3211	F	2	Serotype O121:H19; eae positive; stx1 and/or stx 2 positive; export license required for shipping outside the U.S.
01097L	01097K	01097P	Escherichia coli (O145:NM) derived from CDC 99-3311	F	2	Serotype O145:NM; eae positive; stx1 and/or stx 2 positive; export license required for shipping outside the U.S.
0617L	0617K	0617P	Escherichia coli (O157:H7) derived from ATCC® 35150™*	D	2	Serotype O157:H7; export license required for shipping outside the U.S.
0795L	0795K	0795P	Escherichia coli (O157:H7) derived from ATCC® 43888™*	C	2	Serotype O157:H7; does not produce Shiga-Like Toxin I or II; export license required for shipping outside the U.S.
01204L	01204K	01204P	Escherichia coli (O157:H7) derived from ATCC® 43890™*	D	2	Serotype O157:H7; Produces Shiga-like toxin 1; export license required for shipping outside the U.S.
01100L	01100K	01100P	Escherichia coli (O26:H11) derived from CDC 03-3014	F	2	Serotype O26:H11; eae positive; stx 1 and/or stx 2 positive; export license required for shipping outside the U.S.
01098L	01098K	01098P	Escherichia coli (O45:H2) derived from CDC 00-3039	F	2	Serotype O45:H2; eae positive; stx 1 and/or stx 2 positive; export license required for shipping outside the U.S.
0680L	0680K	0680P	Escherichia coli derived from ATCC® 10536™*	D	1	
01050L	01050K	01050P	Escherichia coli derived from ATCC® 10799™*	E	1	
0681L	0681K	0681P	Escherichia coli derived from ATCC® 11229™*	C	1	
0502L	0502K	0502P	Escherichia coli derived from ATCC® 11303™*	D	1	
0465L	0465K	0465P	Escherichia coli derived from ATCC® 11775™*	C	1	Serovar O1:K1:H7
0747L	0747K	0747P	Escherichia coli derived from ATCC® 13706™*	C	1	



*Look for the ATCC Licensed Derivative® Emblem for all products derived from ATCC® cultures. The ATCC Licensed Derivative Emblem, the ATCC Licenses Derivative Word Mark, and the ATCC Catalog Marks are trademarks of ATCC. Microbiology, Inc. is licensed to use these trademarks and to sell products derived from ATCC® cultures.

KWIK-STIK and LYFO DISK

LYFO DISK	KWIK-STIK 6-Pack	KWIK-STIK 2-Pack	Product Description	Price Code	BSL	Comment
0682L	0682K	0682P	Escherichia coli derived from ATCC® 13762™*	C	1	
0543L	0543K	0543P	Escherichia coli derived from ATCC® 14169™*	C	1	
01037L	01037K	01037P	Escherichia coli derived from ATCC® 15597™*	E	1	Host for MS2 Bacteriophage (ATCC® 15597™-B1)
0203L	0203K	0203P	Escherichia coli derived from ATCC® 23848™*	C	1	Genotype B
0335L	0335K	0335P	Escherichia coli derived from ATCC® 25922™*	A	1	CLSI and EUCAST control for antimicrobial susceptibility testing
0495L	0495K	0495P	Escherichia coli derived from ATCC® 35218™*	C	1	TEM-1 beta-lactamase producer (non-ESBL); CLSI and EUCAST control for antimicrobial susceptibility testing
0422L	0422K	0422P	Escherichia coli derived from ATCC® 35421™*	C	1	
0433L	0433K	0433P	Escherichia coli derived from ATCC® 4157™*	C	1	
0869L	0869K	0869P	Escherichia coli derived from ATCC® 51446™*	C	2	
01233L	01233K	01233P	Escherichia coli derived from ATCC® 51739™*	C	1	
0860L	0860K	0860P	Escherichia coli derived from ATCC® 51755™*	D	1	
0791L	0791K	0791P	Escherichia coli derived from ATCC® 51813™*	D	1	
01137L	01137K	01137P	Escherichia coli derived from ATCC® 700609™*	E	1	Designation CN13; Bacteriophage host
0231L	0231K	0231P	Escherichia coli derived from ATCC® 700728™*	C	1	Serotype O157:H7; nontoxicogenic
0483L	0483K	0483P	Escherichia coli derived from ATCC® 8739™*	C	1	
0115L	0115K	0115P	Escherichia coli derived from ATCC® 9637™*	D	1	
01261L	01261K	01261P	Escherichia coli derived from ATCC® BAA-1429™*	D	1	This is a non-pathogenic E. coli strain recommended by the USDA as a surrogate indicator organism to measure changes in microbial counts
01242L	01242K	01242P	Escherichia coli derived from ATCC® BAA-2452™*	C	2	New Delhi metallo-beta-lactamase (NDM-1) positive; blaNDM positive by PCR; Carbapenem-resistant (Imipenem and Ertapenem)
01113L	01113K	01113P	Escherichia coli derived from ATCC® BAA-2469™*	E	2	New Delhi metallo-beta-lactamase (NDM-1) positive; blaKPC negative by PCR; blaNDM positive by PCR; Carbapenem-resistant (Imipenem and Ertapenem)
01229L	01229K	01229P	Escherichia coli ATCC® BAA-2523™*	C	2	Resistant to Ertapenem
01259L	01259K	01259P	Escherichia coli derived from CDC AR-0346	D	2	Extended-spectrum beta-lactamase (ESBL) positive; contains mcr-1 gene



*Look for the ATCC Licensed Derivative® Emblem for all products derived from ATCC® cultures. The ATCC Licensed Derivative Emblem, the ATCC Licenses Derivative Word Mark, and the ATCC Catalog Marks are trademarks of ATCC. Microbiologics, Inc. is licensed to use these trademarks and to sell products derived from ATCC® cultures.

KWIK-STIK and LYFO DISK

LYFO DISK	KWIK-STIK 6-Pack	KWIK-STIK 2-Pack	Product Description	Price Code	BSL	Comment
01062L	01062K	01062P	Escherichia coli derived from NCTC 8622	C	2	Serovar O126:K7(B16):H2; export license required for shipping outside the U.S.
01109L	01109K	01109P	Escherichia coli derived from NCTC 9001	C	2	
0706L	0706K	0706P	Escherichia coli derived from NCTC 10538	B	1	K12
0861L	0861K	0861P	Escherichia coli derived from NCTC 12900	C	1	Serotype O157:H7; non toxigenic
01193L	01193K	01193P	Escherichia coli derived from NCTC 13167	C	2	
01192L	01192K	01192P	Escherichia coli derived from NCTC 13216	C	2	
01085L	01085K	01085P	Escherichia coli derived from NCTC 13351	D	1	TEM-3 ESBL
01136L	01136K	01136P	Escherichia coli derived from NCTC 13476	D	2	IMP-type
01265L	01265K	01265P	Escherichia coli derived from NCTC 13353	C	2	Routine QC strain for Disk Diffusion and MIC Testing of Beta-Lactam Combination Agents per CLSI M100-28Ed; blaCTX-M-15 gene; susceptible to Cefepime-tazobactam combination
01244L	01244K	01244P	Escherichia coli derived from NCTC 13846	D	2	Colistin resistant; MCR-1 positive; harbors multiple other resistance genes (visit product page at microbiologics.com to view all genes)
Eurotium						
01160L	01160K	01160P	Eurotium rubrum derived from ATCC® 42690™*	E	1	Mold
Finegoldia						
0409L	0409K	0409P	Finegoldia magna derived from ATCC® 29328™*	D	1	
Fluoribacter						
0212L	0212K	0212P	Fluoribacter bozemanai derived from ATCC® 33217™*	E	2	
Fusarium						
0531L	0531K	0531P	Fusarium solani derived from ATCC® 36031™*	E	2	Mold
Fusobacterium						
01191L	01191K	01191P	Fusobacterium mortiferum derived from ATCC® 25557™*	D	1	
0407L	0407K	0407P	Fusobacterium necrophorum subsp. necrophorum derived from ATCC® 25286™*	D	2	
0328L	0328K	0328P	Fusobacterium nucleatum subsp. nucleatum derived from ATCC® 25586™*	D	2	
Gardnerella						
0410L	0410K	0410P	Gardnerella vaginalis derived from ATCC® 14018™*	C	2	



*Look for the ATCC Licensed Derivative® Emblem for all products derived from ATCC® cultures. The ATCC Licensed Derivative Emblem, the ATCC Licenses Derivative Word Mark, and the ATCC Catalog Marks are trademarks of ATCC. Microbiologics, Inc. is licensed to use these trademarks and to sell products derived from ATCC® cultures.

KWIK-STIK and LYFO DISK

LYFO DISK	KWIK-STIK 6-Pack	KWIK-STIK 2-Pack	Product Description	Price Code	BSL	Comment
0643L	0643K	0643P	Gardnerella vaginalis derived from ATCC® 49145™*	C	2	
Geobacillus						
0172L	0172K	0172P	Geobacillus stearothermophilus derived from ATCC® 10149™*	C	1	
0872L	0872K	0872P	Geobacillus stearothermophilus derived from ATCC® 12980™*	B	1	
0871L	0871K	0871P	Geobacillus stearothermophilus derived from ATCC® 7953™*	D	1	
Geotrichum						
0519L	0519K	0519P	Geotrichum candidum derived from ATCC® 34614™*	D	1	Yeast cells
Haemophilus						
0441L	0441K	0441P	Haemophilus influenzae derived from ATCC® 10211™*	C	2	Type b; beta lactamase negative
0376L	0376K	0376P	Haemophilus influenzae derived from ATCC® 19418™*	C	2	
0338L	0338K	0338P	Haemophilus influenzae derived from ATCC® 33533™*	C	2	Type b; beta lactamase producer
0993L	0993K	0993P	Haemophilus influenzae derived from ATCC® 35056™*	D	2	beta lactamase producer
0438L	0438K	0438P	Haemophilus influenzae derived from ATCC® 43065™*	C	2	
0476L	0476K	0476P	Haemophilus influenzae derived from ATCC® 43163™*	C	2	Beta lactamase producer
0644L	0644K	0644P	Haemophilus influenzae derived from ATCC® 49144™*	C	2	Beta lactamase producer
0647L	0647K	0647P	Haemophilus influenzae derived from ATCC® 49247™*	C	2	Reduced susceptibility to beta-lactam agents due to PBP mutations in Haemophilus influenzae; Ampicillin resistant; CLSI and EUCAST control for antimicrobial susceptibility testing
0919L	0919K	0919P	Haemophilus influenzae derived from ATCC® 49766™*	C	2	CLSI and EUCAST antimicrobial susceptibility control strain
0620L	0620K	0620P	Haemophilus influenzae derived from ATCC® 9006™*	C	2	Type A
0185L	0185K	0185P	Haemophilus influenzae derived from ATCC® 9007™*	D	2	Type C
01024L	01024K	01024P	Haemophilus influenzae derived from NCTC 8468	C	2	
0377L	0377K	0377P	Haemophilus parahaemolyticus derived from ATCC® 10014™*	C	2	
01171L	01171K	01171P	Haemophilus parainfluenzae derived from ATCC® 9796™*	C	2	
Hafnia						
0165L	0165K	0165P	Hafnia alvei derived from ATCC® 51815™*	E	1	
Hanseniaspora						



*Look for the ATCC Licensed Derivative® Emblem for all products derived from ATCC® cultures. The ATCC Licensed Derivative Emblem, the ATCC Licenses Derivative Word Mark, and the ATCC Catalog Marks are trademarks of ATCC. Microbiology, Inc. is licensed to use these trademarks and to sell products derived from ATCC® cultures.

KWIK-STIK and LYFO DISK

LYFO DISK	KWIK-STIK 6-Pack	KWIK-STIK 2-Pack	Product Description	Price Code	BSL	Comment
01012L	01012K	01012P	Hanseniaspora valbyensis derived from ATCC® 58370™*	C	1	Formerly Kloeckera japonica; yeast cells
Herminiimonas						
0169L	0169K	0169P	Herminiimonas species derived from ATCC® 49643™*	E	1	Formerly Aquaspirillum species
Issatchenkia						
0227L	0227K	0227P	Issatchenkia orientalis derived from ATCC® 6258™*	D	2	CLSI QC strain for Disk Diffusion and MIC determination; yeast cells
Klebsiella						
0306L	0306K	0306P	Klebsiella aerogenes derived from ATCC® 13048™*	B	1	Quality control for DuPont RiboPrinter® Microbial Characterization System; Formerly Enterobacter aerogenes
0399L	0399K	0399P	Klebsiella aerogenes derived from ATCC® 35029™*	B	1	Formerly Enterobacter aerogenes
0196L	0196K	0196P	Klebsiella aerogenes derived from ATCC® 51697™*	D	1	Formerly Enterobacter aerogenes
0597L	0597K	0597P	Klebsiella aerogenes derived from NCIMB 10102	B	2	Formerly Enterobacter aerogenes
0530L	0530K	0530P	Klebsiella oxytoca derived from ATCC® 13182™*	B	2	
0626L	0626K	0626P	Klebsiella oxytoca derived from ATCC® 49131™*	B	2	
0167L	0167K	0167P	Klebsiella oxytoca derived from ATCC® 51817™*	E	2	
0757L	0757K	0757P	Klebsiella oxytoca derived from ATCC® 700324™*	D	2	
0840L	0840K	0840P	Klebsiella oxytoca derived from ATCC® 8724™*	B	2	
01147L	01147K	01147P	Klebsiella oxytoca derived from NCTC 11686	D	2	
01019L	01019K	01019P	Klebsiella pneumoniae derived from ATCC® BAA-1144™*	D	2	Control strain for the AmpC disk test; weak positive
01005L	01005K	01005P	Klebsiella pneumoniae derived from ATCC® BAA-1705™*	B	2	blaKPC positive; blaNDM negative; Produces carbapenemase KPC; Carbapenem-resistant (imipenem and ertapenem); Modified Hodge Test (MHT) positive control
01006L	01006K	01006P	Klebsiella pneumoniae derived from ATCC® BAA-1706™*	B	2	Modified Hodge Test (MHT) negative control
01060L	01060K	01060P	Klebsiella pneumoniae derived from ATCC® BAA-2146™*	E	2	New Delhi metallo-beta-lactamase (NDM-1) positive; blaNDM positive; blaKPC negative
01263L	01263K	01263P	Klebsiella pneumoniae derived from ATCC® BAA-2814™*	D	2	KPC-3
01153L	01153K	01153P	Klebsiella pneumoniae derived from CDC 1100192	D	2	blaNDM-1 metallo-beta-lactamase gene
	01241K	01241P	Klebsiella pneumoniae derived from CDC AR-0039	C	2	Produces OXA-181 carbapenemase



*Look for the ATCC Licensed Derivative® Emblem for all products derived from ATCC® cultures. The ATCC Licensed Derivative Emblem, the ATCC Licenses Derivative Word Mark, and the ATCC Catalog Marks are trademarks of ATCC. Microbiologics, Inc. is licensed to use these trademarks and to sell products derived from ATCC® cultures.

KWIK-STIK and LYFO DISK

LYFO DISK	KWIK-STIK 6-Pack	KWIK-STIK 2-Pack	Product Description	Price Code	BSL	Comment
	01240K	01240P	Klebsiella pneumoniae derived from CDC AR-0066	C	2	Produces OXA-232 carbapenemase
01117L	01117K	01117P	Klebsiella pneumoniae derived from NCTC 13438	D	2	Produces carbapenemase KPC-3
		01245P	Klebsiella pneumoniae derived from NCTC 13439	C	2	blaVIM-1 gene; Metallo-beta-lactamase positive
01112L	01112K	01112P	Klebsiella pneumoniae derived from NCTC 13440	D	2	Metallo-beta-lactamase positive; VIM-1
01148L	01148K	01148P	Klebsiella pneumoniae derived from NCTC 13442	D	2	OXA 48
01145L	01145K	01145P	Klebsiella pneumoniae derived from NCTC 13443	D	2	NDM-1 positive; New Delhi metallo-beta-lactamase
0684L	0684K	0684P	Klebsiella pneumoniae subsp. pneumoniae derived from ATCC® 10031™*	C	2	Methyl Red positive, Voges-Proskauer negative
0458L	0458K	0458P	Klebsiella pneumoniae subsp. pneumoniae derived from ATCC® 13882™*	B	2	
0351L	0351K	0351P	Klebsiella pneumoniae subsp. pneumoniae derived from ATCC® 13883™*	A	2	Methyl Red positive; Vog; Not thermotolerant: does not grow at 44.5°C
0685L	0685K	0685P	Klebsiella pneumoniae subsp. pneumoniae derived from ATCC® 27736™*	B	2	
0957L	0957K	0957P	Klebsiella pneumoniae subsp. pneumoniae derived from ATCC® 33495™*	C	2	
0942L	0942K	0942P	Klebsiella pneumoniae subsp. pneumoniae derived from ATCC® 35657™*	D	2	
0683L	0683K	0683P	Klebsiella pneumoniae subsp. pneumoniae derived from ATCC® 4352™*	B	2	
0784L	0784K	0784P	Klebsiella pneumoniae subsp. pneumoniae derived from ATCC® 700603™*	D	2	Produces SHV-18; Extended-spectrum beta-lactamase (ESBL) positive; CLSI and EUCAST positive control for ESBL tests
01247L	01247K	01247P	Klebsiella pneumoniae subsp. pneumoniae derived from ATCC® BAA-2524™*	C	2	QC strain for Biomerieux Chrom-ID OXA 48 agar (bMX1103199)
0261L	0261K	0261P	Klebsiella variicola derived from ATCC® 31488™*	D	2	Formerly Klebsiella pneumoniae subsp. pneumoniae; thermotolerant
Kocuria						
0126L	0126K	0126P	Kocuria kristinae derived from ATCC® BAA-752™*	C	1	
0670L	0670K	0670P	Kocuria rhizophila derived from ATCC® 15957™*	E	1	
0669L	0669K	0669P	Kocuria rhizophila derived from ATCC® 9341a™*	C	1	
0688L	0688K	0688P	Kocuria rhizophila derived from ATCC® 9341™*	D	1	
0766L	0766K	0766P	Kocuria rosea derived from ATCC® 186™*	D	1	
Lactobacillus						
0885L	0885K	0885P	Lactobacillus acidophilus derived from ATCC® 314™*	C	1	
0243L	0243K	0243P	Lactobacillus acidophilus derived from ATCC® 4356™*	D	1	



*Look for the ATCC Licensed Derivative® Emblem for all products derived from ATCC® cultures. The ATCC Licensed Derivative Emblem, the ATCC Licenses Derivative Word Mark, and the ATCC Catalog Marks are trademarks of ATCC. Microbiology, Inc. is licensed to use these trademarks and to sell products derived from ATCC® cultures.

KWIK-STIK and LYFO DISK

LYFO DISK	KWIK-STIK 6-Pack	KWIK-STIK 2-Pack	Product Description	Price Code	BSL	Comment
01262L	01262K	01262P	Lactobacillus brevis derived from ATCC® 14869™*	E	1	
0546L	0546K	0546P	Lactobacillus casei derived from ATCC® 334™*	E	1	
0176L	0176K	0176P	Lactobacillus casei derived from ATCC® 393™*	D	1	
0813L	0813K	0813P	Lactobacillus fermentum derived from ATCC® 9338™*	C	1	
0127L	0127K	0127P	Lactobacillus gasseri derived from ATCC® 19992™*	C	1	
0235L	0235K	0235P	Lactobacillus leichmannii derived from ATCC® 7830™*	C	1	Formerly Lactobacillus delbrueckii subsp. lactis
0526L	0526K	0526P	Lactobacillus paracasei subsp. paracasei derived from ATCC® BAA-52™*	D	1	
0234L	0234K	0234P	Lactobacillus plantarum derived from ATCC® 8014™*	D	1	
01144L	01144K	01144P	Lactobacillus plantarum subsp. plantarum derived from ATCC® 14917™*	C	1	
01090L	01090K	01090P	Lactobacillus rhamnosus derived from ATCC® 53103™*	E	1	
0233L	0233K	0233P	Lactobacillus rhamnosus derived from ATCC® 7469™*	D	1	
0989L	0989K	0989P	Lactobacillus rhamnosus derived from ATCC® 9595™*	C	1	
0128L	0128K	0128P	Lactobacillus sakei subsp. sakei derived from ATCC® 15521™*	D	1	
Lactococcus						
0980L	0980K	0980P	Lactococcus lactis derived from ATCC® 49032™*	D	1	
0152L	0152K	0152P	Lactococcus lactis subsp. cremoris derived from ATCC® 19257™*	D	1	
0205L	0205K	0205P	Lactococcus lactis subsp. lactis derived from ATCC® 11454™*	D	1	
0149L	0149K	0149P	Lactococcus lactis subsp. lactis derived from ATCC® 19435™*	D	1	
Legionella						
01195L	01195K	01195P	Legionella anisa derived from ATCC® 35292™*	E	2	
01003L	01003K	01003P	Legionella longbeachae derived from ATCC® 33462™*	E	2	
0211L	0211K	0211P	Legionella pneumophila subsp. pneumophila derived from ATCC® 33152™*	E	2	
Listeria						
0856L	0856K	0856P	Listeria grayi derived from ATCC® 25401™*	D	1	
0222L	0222K	0222P	Listeria grayi derived from ATCC® 700545™*	D	1	
0814L	0814K	0814P	Listeria innocua derived from ATCC® 33090™*	D	1	Serotype 6a
01243L	01243K	01243P	Listeria innocua derived from ATCC® 51742™*	D	1	
0414L	0414K	0414P	Listeria innocua derived from NCTC 11288	D	1	Serotype 6a
0815L	0815K	0815P	Listeria ivanovii subsp. ivanovii derived from ATCC® 19119™*	D	2	
0299L	0299K	0299P	Listeria ivanovii subsp. londoniensis derived from ATCC® BAA-139™*	E	1	Formerly Listeria ivanovii subsp. ivanovii



*Look for the ATCC Licensed Derivative® Emblem for all products derived from ATCC® cultures. The ATCC Licensed Derivative Emblem, the ATCC Licenses Derivative Word Mark, and the ATCC Catalog Marks are trademarks of ATCC. Microbiology, Inc. is licensed to use these trademarks and to sell products derived from ATCC® cultures.

KWIK-STIK and LYFO DISK

LYFO DISK	KWIK-STIK 6-Pack	KWIK-STIK 2-Pack	Product Description	Price Code	BSL	Comment
0254L	0254K	0254P	Listeria monocytogenes Cornell University derived from Silliker® SLR2249	D	2	Act A gene removed
0129L	0129K	0129P	Listeria monocytogenes derived from ATCC® 13932™*	C	2	Serotype 4b
0727L	0727K	0727P	Listeria monocytogenes derived from ATCC® 15313™*	D	2	Non-hemolytic on sheep blood agar
0277L	0277K	0277P	Listeria monocytogenes derived from ATCC® 19111™*	D	2	Serotype 1
0232L	0232K	0232P	Listeria monocytogenes derived from ATCC® 19112™*	D	2	Serotype 2
0686L	0686K	0686P	Listeria monocytogenes derived from ATCC® 19114™*	D	2	Serotype 4a
0687L	0687K	0687P	Listeria monocytogenes derived from ATCC® 19115™*	D	2	Serotype 4b
0154L	0154K	0154P	Listeria monocytogenes derived from ATCC® 19118™*	D	2	Serotype 4e
01190L	01190K	01190P	Listeria monocytogenes derived from ATCC® 35152™*	C	2	Non-hemolytic variation
0398L	0398K	0398P	Listeria monocytogenes derived from ATCC® 7644™*	D	2	
0130L	0130K	0130P	Listeria monocytogenes derived from ATCC® BAA-751™*	C	2	
0783L	0783K	0783P	Listeria monocytogenes derived from NCTC 10890	D	2	Serotype 7
0802L	0802K	0802P	Listeria seeligeri derived from ATCC® 35967™*	D	1	
0816L	0816K	0816P	Listeria welshimeri derived from ATCC® 35897™*	D	1	
Malassezia						
0701L	0701K	0701P	Malassezia furfur derived from ATCC® 14521™*	D	2	Yeast cells
Mannheimia						
0664L	0664K	0664P	Mannheimia haemolytica derived from ATCC® 33396™*	E	2	
Methylobacterium						
01110L	01110K	01110P	Methylobacterium extorquens derived from ATCC® BAA-2500™*	E	1	
01181L	01181K	01181P	Methylobacterium organophilum derived from ATCC® 27886™*	E	1	
Meyerozyma						
0738L	0738K	0738P	Meyerozyma guilliermondii derived from ATCC® 6260™*	D	1	Yeast cells
Microbacterium						
01042L	01042K	01042P	Microbacterium liquefaciens derived from ATCC® BAA-1819™*	D	1	
01041L	01041K	01041P	Microbacterium paraoxydans derived from ATCC® BAA-1818™*	D	1	
0295L	0295K	0295P	Microbacterium testaceum derived from ATCC® 15829™*	D	1	
Micrococcus						
0689L	0689K	0689P	Micrococcus luteus derived from ATCC® 10240™*	C	1	
0242L	0242K	0242P	Micrococcus luteus derived from ATCC® 4698™*	D	1	
0804L	0804K	0804P	Micrococcus luteus derived from ATCC® 49732™*	C	1	
0740L	0740K	0740P	Micrococcus species derived from ATCC® 700405™*	D	1	



*Look for the ATCC Licensed Derivative® Emblem for all products derived from ATCC® cultures. The ATCC Licensed Derivative Emblem, the ATCC Licenses Derivative Word Mark, and the ATCC Catalog Marks are trademarks of ATCC. Microbiologics, Inc. is licensed to use these trademarks and to sell products derived from ATCC® cultures.

KWIK-STIK and LYFO DISK

LYFO DISK	KWIK-STIK 6-Pack	KWIK-STIK 2-Pack	Product Description	Price Code	BSL	Comment
0218L	0218K	0218P	Micrococcus yunnanensis derived from ATCC® 7468™*	C	1	Formerly Micrococcus luteus
Microsporium						
0894L	0894K	0894P	Microsporium canis derived from ATCC® 36299™*	E	2	Mold
0893L	0893K	0893P	Microsporium gypseum derived from ATCC® 24102™*	E	2	Mold
Moraxella						
0248L	0248K	0248P	Moraxella catarrhalis derived from ATCC® 23246™*	D	1	Formerly Moraxella (Branhamella) catarrhalis
0951L	0951K	0951P	Moraxella catarrhalis derived from ATCC® 25238™*	C	1	
0403L	0403K	0403P	Moraxella catarrhalis derived from ATCC® 25240™*	C	1	Formerly Moraxella (Branhamella) catarrhalis
0642L	0642K	0642P	Moraxella catarrhalis derived from ATCC® 49143™*	C	1	Formerly Moraxella (Branhamella) catarrhalis
0622L	0622K	0622P	Moraxella catarrhalis derived from ATCC® 8176™*	C	1	Formerly Moraxella (Branhamella) catarrhalis
0475L	0475K	0475P	Moraxella osloensis derived from ATCC® 10973™*	C	2	Formerly Moraxella (Moraxella) osloensis
Morganella						
0215L	0215K	0215P	Morganella morganii subsp. morganii derived from ATCC® 25829™*	C	2	
0839L	0839K	0839P	Morganella morganii subsp. morganii derived from ATCC® 25830™*	D	2	
Mucor						
01142L	01142K	01142P	Mucor racemosus derived from ATCC® 42647™*	D	1	Mold
01255L	01255K	01255P	Mucor racemosus f. racemosus derived from ATCC® 22365™*	D	1	Mold
Mycobacterium						
01149L	01149K	01149P	Mycobacterium avium derived from ATCC® 700898™*	E	2	
0522L	0522K	0522P	Mycobacterium avium subsp. avium derived from ATCC® 15769™*	E	2	Serotype 1
0544L	0544K	0544P	Mycobacterium avium subsp. avium derived from ATCC® 25291™*	E	2	Serotype 2
0513L	0513K	0513P	Mycobacterium fortuitum subsp. fortuitum derived from ATCC® 6841™*	E	2	
0995L	0995K	0995P	Mycobacterium gordonae derived from ATCC® 14470™*	E	2	
01049L	01049K	01049P	Mycobacterium haemophilum derived from ATCC® 29548™*	E	2	Requires hemin (x factor) for growth
0157L	0157K	0157P	Mycobacterium intracellulare derived from ATCC® 13950™*	E	2	
0545L	0545K	0545P	Mycobacterium kansasii derived from ATCC® 12478™*	E	2	
0721L	0721K	0721P	Mycobacterium smegmatis derived from ATCC® 14468™*	E	1	
0514L	0514K	0514P	Mycobacterium smegmatis derived from ATCC® 19420™*	E	1	



*Look for the ATCC Licensed Derivative® Emblem for all products derived from ATCC® cultures. The ATCC Licensed Derivative Emblem, the ATCC Licenses Derivative Word Mark, and the ATCC Catalog Marks are trademarks of ATCC. Microbiologics, Inc. is licensed to use these trademarks and to sell products derived from ATCC® cultures.

KWIK-STIK and LYFO DISK

LYFO DISK	KWIK-STIK 6-Pack	KWIK-STIK 2-Pack	Product Description	Price Code	BSL	Comment
0114L	0114K	0114P	Mycobacterium smegmatis derived from ATCC® 607™*	E	1	
0272L	0272K	0272P	Mycobacterium terrae derived from ATCC® 15755™*	E	1	
0112L	0112K	0112P	Mycobacterium tuberculosis derived from ATCC® 25177™*	E	2	Attenuated
Mycoplasma						
01053L	01053K	01053P	Mycoplasma bovis derived from ATCC® 25025™*	E	2	
0156L	0156K	0156P	Mycoplasma hominis derived from ATCC® 15488™*	E	2	
0503L	0503K	0503P	Mycoplasma pneumoniae derived from ATCC® 15531™*	E	2	
Myroides						
0324L	0324K	0324P	Myroides odoratus derived from ATCC® 4651™*	D	1	
Neisseria						
0378L	0378K	0378P	Neisseria gonorrhoeae derived from ATCC® 19424™*	C	2	
0375L	0375K	0375P	Neisseria gonorrhoeae derived from ATCC® 31426™*	C	2	Beta lactamase producer
0429L	0429K	0429P	Neisseria gonorrhoeae derived from ATCC® 43069™*	C	2	
0426L	0426K	0426P	Neisseria gonorrhoeae derived from ATCC® 43070™*	C	2	
0648L	0648K	0648P	Neisseria gonorrhoeae derived from ATCC® 49226™*	C	2	Chromosomally mediated penicillin-resistant Neisseria gonorrhoeae; CLSI control for antimicrobial susceptibility testing
0552L	0552K	0552P	Neisseria gonorrhoeae derived from ATCC® 49498™*	C	2	
0952L	0952K	0952P	Neisseria gonorrhoeae derived from ATCC® 49981™*	D	2	Penicillin resistant Neisseria
01239L	01239K	01239P	Neisseria gonorrhoeae derived from CDC 10328	C	2	According to the CDC document, "Neisseria gonorrhoeae Reference Strains for Susceptibility Testing," this strain is intermediate to ciprofloxacin (CipI)
01222L	01222K	01222P	Neisseria gonorrhoeae derived from CDC 10329	C	2	According to the CDC document, "Neisseria gonorrhoeae Reference Strains for Susceptibility Testing," this isolate is resistant to ciprofloxacin (CipR)
01216L	01216K	01216P	Neisseria gonorrhoeae derived from CDC F-18	C	2	This strain is susceptible to relevant antimicrobial agents per the CDC document, "Neisseria gonorrhoeae Reference Strains for Susceptibility Testing"



*Look for the ATCC Licensed Derivative® Emblem for all products derived from ATCC® cultures. The ATCC Licensed Derivative Emblem, the ATCC Licenses Derivative Word Mark, and the ATCC Catalog Marks are trademarks of ATCC. Microbiology, Inc. is licensed to use these trademarks and to sell products derived from ATCC® cultures.

KWIK-STIK and LYFO DISK

LYFO DISK	KWIK-STIK 6-Pack	KWIK-STIK 2-Pack	Product Description	Price Code	BSL	Comment
01217L	01217K	01217P	Neisseria gonorrhoeae derived from CDC F-28	C	2	According to the CDC document, "Neisseria gonorrhoeae Reference Strains for Susceptibility Testing," this strain is resistant to spectinomycin (SpCR)
01219L	01219K	01219P	Neisseria gonorrhoeae derived from CDC SPJ-15	C	2	According to the CDC document, "Neisseria gonorrhoeae Reference Strains for Susceptibility Testing," this is an isolate with a critical MIC greater than or equal to 1.0 ug/ml of azithromycin (AznC)
01218L	01218K	01218P	Neisseria gonorrhoeae derived from CDC SPL-4	C	2	According to the CDC document, "Neisseria gonorrhoeae Reference Strains for Susceptibility Testing," this strain exhibits decreased sensitivity to cefixime (CfxDS)
0405L	0405K	0405P	Neisseria lactamica derived from ATCC® 23970™*	C	2	
0943L	0943K	0943P	Neisseria lactamica derived from ATCC® 23971™*	C	2	
0646L	0646K	0646P	Neisseria lactamica derived from ATCC® 49142™*	C	2	
0453L	0453K	0453P	Neisseria meningitidis derived from ATCC® 13077™*	C	2	Serogroup A
0454L	0454K	0454P	Neisseria meningitidis derived from ATCC® 13090™*	C	2	Serogroup B
0404L	0404K	0404P	Neisseria meningitidis derived from ATCC® 13102™*	C	2	Serogroup C
0649L	0649K	0649P	Neisseria meningitidis derived from NCTC 10026	E	2	Serogroup B
0131L	0131K	0131P	Neisseria mucosa derived from ATCC® 49233™*	D	2	
0464L	0464K	0464P	Neisseria sicca derived from ATCC® 29193™*	D	1	
0406L	0406K	0406P	Neisseria sicca derived from ATCC® 9913™*	C	1	
Nocardia						
0866L	0866K	0866P	Nocardia brasiliensis derived from ATCC® 19296™*	D	2	
Ochrobactrum						
0132L	0132K	0132P	Ochrobactrum anthropi derived from ATCC® BAA-749™*	C	1	
Oligella						
0868L	0868K	0868P	Oligella ureolytica derived from ATCC® 43534™*	C	1	
0621L	0621K	0621P	Oligella urethralis derived from ATCC® 17960™*	C	2	
Paenibacillus						
0473L	0473K	0473P	Paenibacillus gordonae derived from ATCC® 29948™*	C	1	
0431L	0431K	0431P	Paenibacillus larvae subsp. larvae derived from ATCC® 9545™*	E	1	
0142L	0142K	0142P	Paenibacillus macerans derived from ATCC® 8509™*	C	1	
0228L	0228K	0228P	Paenibacillus polymyxa derived from ATCC® 43865™*	B	1	



*Look for the ATCC Licensed Derivative® Emblem for all products derived from ATCC® cultures. The ATCC Licensed Derivative Emblem, the ATCC Licenses Derivative Word Mark, and the ATCC Catalog Marks are trademarks of ATCC. Microbiology, Inc. is licensed to use these trademarks and to sell products derived from ATCC® cultures.

KWIK-STIK and LYFO DISK

LYFO DISK	KWIK-STIK 6-Pack	KWIK-STIK 2-Pack	Product Description	Price Code	BSL	Comment
0296L	0296K	0296P	Paenibacillus polymyxa derived from ATCC® 7070™*	D	1	
0883L	0883K	0883P	Paenibacillus polymyxa derived from ATCC® 842™*	D	1	
Parabacteroides						
0618L	0618K	0618P	Parabacteroides distasonis derived from ATCC® 8503™*	D	2	
0584L	0584K	0584P	Parabacteroides distasonis derived from ATCC® BAA-1295™*	D	2	
Parvimonas						
0958L	0958K	0958P	Parvimonas micra derived from ATCC® 33270™*	D	1	
Pasteurella						
0668L	0668K	0668P	Pasteurella multocida subsp. multocida derived from ATCC® 12945™*	C	2	
Pediococcus						
0259L	0259K	0259P	Pediococcus acidilactici derived from ATCC® 8042™*	C	1	
01075L	01075K	01075P	Pediococcus pentosaceus derived from ATCC® 33316™*	E	1	
Penicillium						
0178L	0178K	0178P	Penicillium chrysogenum derived from ATCC® 10106™*	E	1	Mold
01133L	01133K	01133P	Penicillium citrinum derived from ATCC® 9849™*	E	1	Mold
01252L	01252K	01252P	Penicillium corylophilum derived from ATCC® 9784™*	E	1	Mold
01200L	01200K	01200P	Penicillium rubens derived from ATCC® 11709™*	E	1	Mold; produces penicillin; formerly Penicillium chrysogenum
0207L	0207K	0207P	Penicillium rubens derived from ATCC® 9179™*	D	1	Mold
0794L	0794K	0794P	Penicillium venetum derived from ATCC® 16025™*	E	1	Mold
Peptostreptococcus						
0322L	0322K	0322P	Peptostreptococcus anaerobius derived from ATCC® 27337™*	D	1	
Pluralibacter						
0703L	0703K	0703P	Pluralibacter gergoviae derived from ATCC® 33028™*	D	2	Formerly Enterobacter gergoviae
Porphyromonas						
0912L	0912K	0912P	Porphyromonas gingivalis derived from ATCC® 33277™*	D	2	
Prevotella						
01187L	01187K	01187P	Prevotella intermedia derived from ATCC® 25611™*	E	2	
0110L	0110K	0110P	Prevotella melaninogenica derived from ATCC® 25845™*	D	2	
Proteus						
0355L	0355K	0355P	Proteus hauseri derived from ATCC® 13315™*	B	2	
0440L	0440K	0440P	Proteus mirabilis derived from ATCC® 12453™*	B	2	
01116L	01116K	01116P	Proteus mirabilis derived from ATCC® 21100™*	D	2	
0690L	0690K	0690P	Proteus mirabilis derived from ATCC® 25933™*	D	2	



*Look for the ATCC Licensed Derivative® Emblem for all products derived from ATCC® cultures. The ATCC Licensed Derivative Emblem, the ATCC Licenses Derivative Word Mark, and the ATCC Catalog Marks are trademarks of ATCC. Microbiology, Inc. is licensed to use these trademarks and to sell products derived from ATCC® cultures.

KWIK-STIK and LYFO DISK

LYFO DISK	KWIK-STIK 6-Pack	KWIK-STIK 2-Pack	Product Description	Price Code	BSL	Comment
0321L	0321K	0321P	Proteus mirabilis derived from ATCC® 29245™*	B	2	
01215L	01215K	01215P	Proteus mirabilis derived from ATCC® 29906™*	C	2	
0190L	0190K	0190P	Proteus mirabilis derived from ATCC® 33583™*	D	2	
0944L	0944K	0944P	Proteus mirabilis derived from ATCC® 35659™*	D	2	
0432L	0432K	0432P	Proteus mirabilis derived from ATCC® 43071™*	B	2	
0607L	0607K	0607P	Proteus mirabilis derived from ATCC® 7002™*	B	2	
0310L	0310K	0310P	Proteus mirabilis derived from NCIMB 13283	D	2	
01152L	01152K	01152P	Proteus vulgaris derived from ATCC® 29905™*	D	2	
0300L	0300K	0300P	Proteus vulgaris derived from ATCC® 33420™*	B	2	
0640L	0640K	0640P	Proteus vulgaris derived from ATCC® 49132™*	B	2	
0459L	0459K	0459P	Proteus vulgaris derived from ATCC® 6380™*	B	2	
0841L	0841K	0841P	Proteus vulgaris derived from ATCC® 6896™*	B	2	
0691L	0691K	0691P	Proteus vulgaris derived from ATCC® 8427™*	B	2	
0393L	0393K	0393P	Proteus vulgaris derived from NCTC 4636	C	2	
Prototheca						
0780L	0780K	0780P	Prototheca wickerhamii derived from ATCC® 16529™*	D	1	Yeast cells
Providencia						
0692L	0692K	0692P	Providencia alcalifaciens derived from ATCC® 9886™*	C	1	
0997L	0997K	0997P	Providencia rettgeri derived from ATCC® 9250™*	D	2	
0384L	0384K	0384P	Providencia stuartii derived from ATCC® 33672™*	C	1	
0879L	0879K	0879P	Providencia stuartii derived from ATCC® 49809™*	C	1	
Pseudomonas						
0416L	0416K	0416P	Pseudomonas aeruginosa derived from ATCC® 10145™**	B	2	
01078L	01078K	01078P	Pseudomonas aeruginosa derived from ATCC® 13388™*	E	2	
0693L	0693K	0693P	Pseudomonas aeruginosa derived from ATCC® 15442™*	C	2	Pyocyanin not produced
0199L	0199K	0199P	Pseudomonas aeruginosa derived from ATCC® 19429™*	D	2	
0695L	0695K	0695P	Pseudomonas aeruginosa derived from ATCC® 25619™*	C	2	



*Look for the ATCC Licensed Derivative® Emblem for all products derived from ATCC® cultures. The ATCC Licensed Derivative Emblem, the ATCC Licenses Derivative Word Mark, and the ATCC Catalog Marks are trademarks of ATCC. Microbiologics, Inc. is licensed to use these trademarks and to sell products derived from ATCC® cultures.

KWIK-STIK and LYFO DISK

LYFO DISK	KWIK-STIK 6-Pack	KWIK-STIK 2-Pack	Product Description	Price Code	BSL	Comment
0353L	0353K	0353P	<i>Pseudomonas aeruginosa</i> derived from ATCC® 27853™*	A	2	Contains inducible AmpC beta-lactamase; CLSI and EUCAST control for antimicrobial susceptibility testing; Microbiologics does not recommend the use of this strain for testing Ceftriaxone using the disk diffusion method. We have found that this strain is displaying resistance to Ceftriaxone using this method - this strain may not give consistent test results for the Ceftriaxone MIC well.
0975L	0975K	0975P	<i>Pseudomonas aeruginosa</i> derived from ATCC® 35032™*	C	2	
0182L	0182K	0182P	<i>Pseudomonas aeruginosa</i> derived from ATCC® 35554™*	D	2	
0484L	0484K	0484P	<i>Pseudomonas aeruginosa</i> derived from ATCC® 9027™**	B	2	
01009L	01009K	01009P	<i>Pseudomonas aeruginosa</i> derived from ATCC® 9721™*	B	2	
01010L	01010K	01010P	<i>Pseudomonas aeruginosa</i> derived from ATCC® BAA-1744™*	B	2	
0598L	0598K	0598P	<i>Pseudomonas aeruginosa</i> derived from NCIMB 12469	C	2	Microbiologics does not recommend the use of this strain for testing Ceftriaxone using the disk diffusion method. We have found that this strain is displaying resistance to Ceftriaxone using this method.
0304L	0304K	0304P	<i>Pseudomonas aeruginosa</i> derived from NCIMB 8295	C	2	
0576L	0576K	0576P	<i>Pseudomonas aeruginosa</i> derived from NCIMB 8626	C	2	
0830L	0830K	0830P	<i>Pseudomonas aeruginosa</i> derived from NCTC 10662	D	2	
0168L	0168K	0168P	<i>Pseudomonas brenneri</i> derived from ATCC® 49642™*	E	1	Formerly <i>Pseudomonas fluorescens</i>
0241L	0241K	0241P	<i>Pseudomonas fluorescens</i> derived from ATCC® 13525™*	D	1	
0880L	0880K	0880P	<i>Pseudomonas mosselii</i> derived from ATCC® 49838™*	C	1	Formerly <i>Pseudomonas fluorescens</i>
0524L	0524K	0524P	<i>Pseudomonas protegens</i> (G) derived from ATCC® 17386™*	D	1	
0702L	0702K	0702P	<i>Pseudomonas putida</i> derived from ATCC® 31483™*	E	1	
0627L	0627K	0627P	<i>Pseudomonas putida</i> derived from ATCC® 49128™*	C	1	
0853L	0853K	0853P	<i>Pseudomonas stutzeri</i> derived from ATCC® 17588™*	D	1	
Ralstonia						
0641L	0641K	0641P	<i>Ralstonia insidiosa</i> derived from ATCC® 49129™*	C	1	Formerly <i>Ralstonia pickettii</i>
01159L	01159K	01159P	<i>Ralstonia pickettii</i> derived from ATCC® 27511™*	D	1	
01197L	01197K	01197P	<i>Ralstonia pickettii</i> derived from ATCC® 700591™*	D	1	
Raoultella						



*Look for the ATCC Licensed Derivative® Emblem for all products derived from ATCC® cultures. The ATCC Licensed Derivative Emblem, the ATCC Licenses Derivative Word Mark, and the ATCC Catalog Marks are trademarks of ATCC. Microbiologics, Inc. is licensed to use these trademarks and to sell products derived from ATCC® cultures.

KWIK-STIK and LYFO DISK

LYFO DISK	KWIK-STIK 6-Pack	KWIK-STIK 2-Pack	Product Description	Price Code	BSL	Comment
0191L	0191K	0191P	Raoultella terrigena derived from ATCC® 33257™*	E	2	
Rhizopus						
0208L	0208K	0208P	Rhizopus stolonifer (-) derived from ATCC® 6227a™*	E	1	Mold
0209L	0209K	0209P	Rhizopus stolonifer (+) derived from ATCC® 6227b™*	E	1	Mold
Rhodococcus						
0697L	0697K	0697P	Rhodococcus equi derived from ATCC® 6939™*	D	2	
Rhodotorula						
0143L	0143K	0143P	Rhodotorula mucilaginosa derived from ATCC® 66034™*	D	2	Yeast cells
Saccharomyces						
01066L	01066K	01066P	Saccharomyces cerevisiae derived from ATCC® 18824™*	E	1	Yeast cells
0534L	0534K	0534P	Saccharomyces cerevisiae derived from ATCC® 4098™*	D	1	Yeast cells
0186L	0186K	0186P	Saccharomyces cerevisiae derived from ATCC® 7754™*	E	1	Yeast cells
0900L	0900K	0900P	Saccharomyces cerevisiae derived from ATCC® 9080™*	D	1	Yeast cells
0699L	0699K	0699P	Saccharomyces cerevisiae derived from ATCC® 9763™*	D	1	Yeast cells
0736L	0736K	0736P	Saccharomyces cerevisiae derived from NCYC 79	D	1	Yeast cells
0374L	0374K	0374P	Saccharomyces cerevisiae derived from NCYC 853	D	1	Yeast cells
0698L	0698K	0698P	Saccharomyces kudriavzevii derived from ATCC® 2601™*	D	1	Formerly Saccharomyces cerevisiae; yeast cells
Salmonella						
0595L	0595K	0595P	Salmonella bongori derived from ATCC® 43975™*	E	2	
0901L	0901K	0901P	Salmonella enterica subsp. arizonae derived from ATCC® 13314™*	D	2	
01054L	01054K	01054P	Salmonella enterica subsp. diarizonae derived from ATCC® 12325™*	E	2	Lactose broth positive; H2S positive
01045L	01045K	01045P	Salmonella enterica subsp. diarizonae derived from ATCC® 29934™*	E	2	Lactose broth positive; H2S negative
0501L	0501K	0501P	Salmonella enterica subsp. enterica derived from ATCC® 51741™*	D	2	H2S negative; formerly Salmonella choleraesuis subsp. choleraesuis serovar Infantis
0817L	0817K	0817P	Salmonella enterica subsp. enterica serovar Abaetetuba derived from ATCC® 35640™*	D	2	
0826L	0826K	0826P	Salmonella enterica subsp. enterica serovar Abaetetuba derived from Silliker® SLR156	C	2	
0890L	0890K	0890P	Salmonella enterica subsp. enterica serovar Abony derived from NCTC 6017	C	2	Serovar Abony
0346L	0346K	0346P	Salmonella enterica subsp. enterica serovar Anatum derived from ATCC® 9270™*	C	2	Group E
01056L	01056K	01056P	Salmonella enterica subsp. enterica serovar Bispebjerg derived from ATCC® 9842™*	E	2	H2S negative; formerly Salmonella Abortusequi
0902L	0902K	0902P	Salmonella enterica subsp. enterica serovar Choleraesuis derived from ATCC® 10708™*	C	2	H2S negative



*Look for the ATCC Licensed Derivative® Emblem for all products derived from ATCC® cultures. The ATCC Licensed Derivative Emblem, the ATCC Licenses Derivative Word Mark, and the ATCC Catalog Marks are trademarks of ATCC. Microbiology, Inc. is licensed to use these trademarks and to sell products derived from ATCC® cultures.

KWIK-STIK and LYFO DISK

LYFO DISK	KWIK-STIK 6-Pack	KWIK-STIK 2-Pack	Product Description	Price Code	BSL	Comment
0343L	0343K	0343P	Salmonella enterica subsp. enterica serovar Choleraesuis derived from ATCC® 7001™*	C	2	Group C; H2S negative
0345L	0345K	0345P	Salmonella enterica subsp. enterica serovar Enteritidis derived from ATCC® 13076™*	C	2	Group D
01103L	01103K	01103P	Salmonella enterica subsp. enterica serovar Enteritidis derived from ATCC® 49223™*	E	2	
01095L	01095K	01095P	Salmonella enterica subsp. enterica serovar Newport derived from ATCC® 6962™*	D	2	
0341L	0341K	0341P	Salmonella enterica subsp. enterica serovar Paratyphi A derived from ATCC® 9150™*	C	2	Group A; H2S negative
01170L	01170K	01170P	Salmonella enterica subsp. enterica serovar Paratyphi B derived from ATCC® 8759™*	C	2	
0851L	0851K	0851P	Salmonella enterica subsp. enterica serovar Poona derived from NCTC 4840	C	2	
0604L	0604K	0604P	Salmonella enterica subsp. enterica serovar Pullorum derived from ATCC® 13036™*	D	2	H2S negative
0344L	0344K	0344P	Salmonella enterica subsp. enterica serovar Tallahassee derived from ATCC® 12002™*	D	2	
0421L	0421K	0421P	Salmonella enterica subsp. enterica serovar Typhimurium derived from ATCC® 13311™*	D	2	
0363L	0363K	0363P	Salmonella enterica subsp. enterica serovar Typhimurium derived from ATCC® 14028™*	C	2	
0253L	0253K	0253P	Salmonella enterica subsp. enterica serovar Typhimurium derived from ATCC® 25241™*	C	2	
0180L	0180K	0180P	Salmonella enterica subsp. enterica serovar Typhimurium derived from ATCC® 51812™*	D	2	
0340L	0340K	0340P	Salmonella enterica subsp. enterica serovar Typhimurium derived from NCTC 74	D	2	
0342L	0342K	0342P	Salmonella enterica subsp. enterica serovar Vellore derived from ATCC® 15611™*	D	2	Group B
01087L	01087K	01087P	Salmonella enterica subsp. salamae serotype Tranaroa derived from NCTC 10252	D	2	Serotype Tranaroa
Serratia						
0838L	0838K	0838P	Serratia liquefaciens derived from ATCC® 27592™*	C	1	
0247L	0247K	0247P	Serratia marcescens derived from ATCC® 13880™*	D	1	
0506L	0506K	0506P	Serratia marcescens derived from ATCC® 14041™*	D	1	Pigmented
0806L	0806K	0806P	Serratia marcescens derived from ATCC® 14756™*	D	1	
0216L	0216K	0216P	Serratia marcescens derived from ATCC® 43861™*	C	1	
0262L	0262K	0262P	Serratia marcescens derived from ATCC® 43862™*	C	1	
0354L	0354K	0354P	Serratia marcescens derived from ATCC® 8100™*	C	1	
01146L	01146K	01146P	Serratia marcescens derived from NCTC 9743	C	2	
Shewanella						
0638L	0638K	0638P	Shewanella haliotis derived from ATCC® 49138™*	C	1	Formerly Shewanella putrefaciens



*Look for the ATCC Licensed Derivative® Emblem for all products derived from ATCC® cultures. The ATCC Licensed Derivative Emblem, the ATCC Licenses Derivative Word Mark, and the ATCC Catalog Marks are trademarks of ATCC. Microbiologics, Inc. is licensed to use these trademarks and to sell products derived from ATCC® cultures.

KWIK-STIK and LYFO DISK

LYFO DISK	KWIK-STIK 6-Pack	KWIK-STIK 2-Pack	Product Description	Price Code	BSL	Comment
0888L	0888K	0888P	Shewanella putrefaciens derived from ATCC® 8071™*	D	1	
Shigella						
01209L	01209K	01209P	Shigella boydii (2) derived from ATCC® 8700™*	C	2	Serotype 2
0349L	0349K	0349P	Shigella boydii derived from ATCC® 9207™*	C	2	Serotype 1
01235L	01235K	01235P	Shigella dysenteriae derived from ATCC® 13313™*	D	2	Export license required for shipping outside the U.S.
0356L	0356K	0356P	Shigella flexneri derived from ATCC® 12022™*	C	2	Serotype 2b
0348L	0348K	0348P	Shigella flexneri derived from ATCC® 9199™*	C	2	Serotype 1a
0303L	0303K	0303P	Shigella sonnei derived from ATCC® 25931™*	C	2	
0350L	0350K	0350P	Shigella sonnei derived from ATCC® 29930™*	D	2	
0446L	0446K	0446P	Shigella sonnei derived from ATCC® 9290™*	B	2	
0705L	0705K	0705P	Shigella sonnei derived from NCTC 12984	C	2	
Sphingobacterium						
0948L	0948K	0948P	Sphingobacterium multivorum derived from ATCC® 35656™*	C	2	
Sphingomonas						
0274L	0274K	0274P	Sphingomonas paucimobilis derived from ATCC® 29837™*	C	2	
Sporidiobolus						
01013L	01013K	01013P	Sporidiobolus salmonicolor derived from ATCC® MYA-4550™*	D	1	Yeast cells
Staphylococcus						
0179L	0179K	0179P	Staphylococcus aureus derived from ATCC® BAA-1026™*	D	2	
01007L	01007K	01007P	Staphylococcus aureus derived from ATCC® BAA-1708™*	D	2	mecA positive; SCCmec type II positive; Methicillin resistant; mupA positive; CLSI screening control for high level mupirocin resistance
01122L	01122K	01122P	Staphylococcus aureus derived from ATCC® BAA-2312™*	D	2	mecC positive; SCCmec type XI positive; Methicillin resistant; this strain contains a divergent mecA gene that is not detected by standard PCR kits
01065L	01065K	01065P	Staphylococcus aureus derived from NCTC 12493	C	2	mecA positive; Methicillin resistant; EUCAST QC strain for cefoxitin
0831L	0831K	0831P	Staphylococcus aureus derived from NCTC 6571	B	2	
0462L	0462K	0462P	Staphylococcus aureus subsp. aureus derived from ATCC® 11632™*	C	2	Beta lactamase producer
01246L	01246K	01246P	Staphylococcus aureus subsp. aureus derived from ATCC® 12598™*	C	2	Cowan's serotype 1; contains a protein A



*Look for the ATCC Licensed Derivative® Emblem for all products derived from ATCC® cultures. The ATCC Licensed Derivative Emblem, the ATCC Licenses Derivative Word Mark, and the ATCC Catalog Marks are trademarks of ATCC. Microbiologics, Inc. is licensed to use these trademarks and to sell products derived from ATCC® cultures.

KWIK-STIK and LYFO DISK

LYFO DISK	KWIK-STIK 6-Pack	KWIK-STIK 2-Pack	Product Description	Price Code	BSL	Comment
0173L	0173K	0173P	Staphylococcus aureus subsp. aureus derived from ATCC® 12600™*	D	2	
0360L	0360K	0360P	Staphylococcus aureus subsp. aureus derived from ATCC® 25923™*	A	2	mecA negative; CAMP test control; CLSI control for antimicrobial susceptibility testing using disk diffusion method
0365L	0365K	0365P	Staphylococcus aureus subsp. aureus derived from ATCC® 29213™*	A	2	mecA negative; weak beta-lactamase producing strain; Oxacillin sensitive; EUCAST QC strain for Disk Diffusion; CLSI and EUCAST QC strain for MIC determination
0906L	0906K	0906P	Staphylococcus aureus subsp. aureus derived from ATCC® 29737™*	C	2	
0496L	0496K	0496P	Staphylococcus aureus subsp. aureus derived from ATCC® 33591™*	C	2	Methicillin resistant
0889L	0889K	0889P	Staphylococcus aureus subsp. aureus derived from ATCC® 33592™*	B	2	mecA positive; SCCmec type III positive; Methicillin and gentamicin resistant
0352L	0352K	0352P	Staphylococcus aureus subsp. aureus derived from ATCC® 33862™*	B	2	Recommended for CAMP Test
0852L	0852K	0852P	Staphylococcus aureus subsp. aureus derived from ATCC® 43300™*	C	2	mecA positive; SCCmec type II positive; Methicillin and oxacillin resistant; CLSI control for cefoxitin disk diffusion, oxacillin agar, and antimicrobial susceptibility testing
0937L	0937K	0937P	Staphylococcus aureus subsp. aureus derived from ATCC® 49476™*	D	2	
0832L	0832K	0832P	Staphylococcus aureus subsp. aureus derived from ATCC® 51153™*	D	2	
0159L	0159K	0159P	Staphylococcus aureus subsp. aureus derived from ATCC® 51740™*	D	2	
0827L	0827K	0827P	Staphylococcus aureus subsp. aureus derived from ATCC® 6538P™*	C	2	
0485L	0485K	0485P	Staphylococcus aureus subsp. aureus derived from ATCC® 6538™*	C	2	
01022L	01022K	01022P	Staphylococcus aureus subsp. aureus derived from ATCC® 700698™*	E	2	mecA positive; SCCmec type II positive; Methicillin resistant; Heterogeneous susceptibility to vancomycin; GRD Etest® control
0158L	0158K	0158P	Staphylococcus aureus subsp. aureus derived from ATCC® 700699™*	D	2	mecA positive; SCCmec type II positive; Methicillin resistant; reduced vancomycin susceptibility, Mu50; absence of pvl gene; propagate on BHI with 4 µg/l vancomycin in order to retain reduced susceptibility



*Look for the ATCC Licensed Derivative® Emblem for all products derived from ATCC® cultures. The ATCC Licensed Derivative Emblem, the ATCC Licenses Derivative Word Mark, and the ATCC Catalog Marks are trademarks of ATCC. Microbiologics, Inc. is licensed to use these trademarks and to sell products derived from ATCC® cultures.

KWIK-STIK and LYFO DISK

LYFO DISK	KWIK-STIK 6-Pack	KWIK-STIK 2-Pack	Product Description	Price Code	BSL	Comment
0113L	0113K	0113P	Staphylococcus aureus subsp. aureus derived from ATCC® 9144™*	D	2	
01055L	01055K	01055P	Staphylococcus aureus subsp. aureus derived from ATCC® BAA-44™*	D	2	Methicillin-resistant
0146L	0146K	0146P	Staphylococcus aureus subsp. aureus derived from ATCC® BAA-976™*	C	2	Clindamycin sensitive; negative control for inducible clindamycin resistant D-zone test; positive for msrA-mediated macrolide-only resistance
0147L	0147K	0147P	Staphylococcus aureus subsp. aureus derived from ATCC® BAA-977™*	C	2	Positive control for inducible clindamycin resistant D-zone test; positive for ermA-mediated resistance
0312L	0312K	0312P	Staphylococcus aureus subsp. aureus derived from NCIMB 12702	A	2	
0713L	0713K	0713P	Staphylococcus aureus subsp. aureus derived from NCTC 12973	C	2	
0533L	0533K	0533P	Staphylococcus capitis derived from ATCC® 146™*	E	1	Formerly Staphylococcus epidermidis
0963L	0963K	0963P	Staphylococcus capitis subsp. capitis derived from ATCC® 35661™*	C	1	
0371L	0371K	0371P	Staphylococcus epidermidis derived from ATCC® 12228™*	B	1	
0412L	0412K	0412P	Staphylococcus epidermidis derived from ATCC® 14990™*	B	1	
01189L	01189K	01189P	Staphylococcus epidermidis derived from ATCC® 35984™*	E	1	
0628L	0628K	0628P	Staphylococcus epidermidis derived from ATCC® 49134™*	C	2	
0976L	0976K	0976P	Staphylococcus epidermidis derived from ATCC® 49461™*	C	2	
01068L	01068K	01068P	Staphylococcus epidermidis derived from ATCC® 51625™*	E	2	Methicillin resistant
0571L	0571K	0571P	Staphylococcus epidermidis derived from NCIMB 8853	C	1	
0629L	0629K	0629P	Staphylococcus gallinarum derived from ATCC® 49148™*	D	2	Formerly Staphylococcus xylosum
0246L	0246K	0246P	Staphylococcus haemolyticus derived from ATCC® 29970™*	D	2	
0739L	0739K	0739P	Staphylococcus lentus derived from ATCC® 700403™*	D	1	
0217L	0217K	0217P	Staphylococcus lugdunensis derived from ATCC® 49576™*	B	1	
0762L	0762K	0762P	Staphylococcus lugdunensis derived from ATCC® 700328™*	D	2	
01150L	01150K	01150P	Staphylococcus lugdunensis derived from NCTC 7990	D	2	
0907L	0907K	0907P	Staphylococcus pseudintermedius derived from ATCC® 49444™*	C	2	Formerly Staphylococcus aureus subsp. aureus; recommended for CAMP test for Listeria monocytogenes



*Look for the ATCC Licensed Derivative® Emblem for all products derived from ATCC® cultures. The ATCC Licensed Derivative Emblem, the ATCC Licenses Derivative Word Mark, and the ATCC Catalog Marks are trademarks of ATCC. Microbiology, Inc. is licensed to use these trademarks and to sell products derived from ATCC® cultures.

KWIK-STIK and LYFO DISK

LYFO DISK	KWIK-STIK 6-Pack	KWIK-STIK 2-Pack	Product Description	Price Code	BSL	Comment
0494L	0494K	0494P	Staphylococcus saprophyticus derived from ATCC® 15305™*	B	1	
01035L	01035K	01035P	Staphylococcus saprophyticus derived from ATCC® 35552™*	D	1	
0945L	0945K	0945P	Staphylococcus saprophyticus derived from ATCC® 49453™*	D	1	
0881L	0881K	0881P	Staphylococcus saprophyticus derived from ATCC® 49907™*	D	1	
0134L	0134K	0134P	Staphylococcus saprophyticus derived from ATCC® BAA-750™*	B	1	
0764L	0764K	0764P	Staphylococcus sciuri subsp. sciuri derived from ATCC® 29061™*	D	1	
01067L	01067K	01067P	Staphylococcus species derived from ATCC® 27626™*	E	1	
0946L	0946K	0946P	Staphylococcus warneri derived from ATCC® 49454™*	C	1	
0605L	0605K	0605P	Staphylococcus xylosus derived from ATCC® 29971™*	D	2	
0741L	0741K	0741P	Staphylococcus xylosus derived from ATCC® 700404™*	D	1	
Stenotrophomonas						
01020L	01020K	01020P	Stenotrophomonas maltophilia derived from ATCC® 13636™*	D	1	Positive control for Etest® metallo Beta-Lactamase strip
0369L	0369K	0369P	Stenotrophomonas maltophilia derived from ATCC® 13637™*	C	1	
0759L	0759K	0759P	Stenotrophomonas maltophilia derived from ATCC® 17666™*	C	1	
0135L	0135K	0135P	Stenotrophomonas maltophilia derived from ATCC® 49130™*	B	1	
0742L	0742K	0742P	Stenotrophomonas maltophilia derived from ATCC® 51331™*	D	1	
Streptococcus						
01234L	01234K	01234P	Streptococcus agalactiae (III) derived from ATCC® BAA-22™*	C	2	Serotype III
0439L	0439K	0439P	Streptococcus agalactiae derived from ATCC® 12386™*	C	2	Group B
0104L	0104K	0104P	Streptococcus agalactiae derived from ATCC® 12403™*	E	2	Group B; Type III
0370L	0370K	0370P	Streptococcus agalactiae derived from ATCC® 13813™*	B	2	Group B; nonhemolytic in absence of CAMP Factor
0436L	0436K	0436P	Streptococcus agalactiae derived from ATCC® 27956™*	B	2	Group B
0105L	0105K	0105P	Streptococcus agalactiae derived from ATCC® BAA-611™*	D	2	Group B; serotype V
0709L	0709K	0709P	Streptococcus agalactiae derived from NCIMB 701348	C	2	Group B
0480L	0480K	0480P	Streptococcus agalactiae derived from NCTC 8017	C	2	Group B
0710L	0710K	0710P	Streptococcus agalactiae derived from NCTC 9993	E	2	Group B
01077L	01077K	01077P	Streptococcus anginosus derived from ATCC® 33397™*	C	2	Group G
0389L	0389K	0389P	Streptococcus anginosus derived from NCTC 10713	D	2	Group G
0463L	0463K	0463P	Streptococcus bovis derived from ATCC® 33317™*	C	1	



*Look for the ATCC Licensed Derivative® Emblem for all products derived from ATCC® cultures. The ATCC Licensed Derivative Emblem, the ATCC Licenses Derivative Word Mark, and the ATCC Catalog Marks are trademarks of ATCC. Microbiology, Inc. is licensed to use these trademarks and to sell products derived from ATCC® cultures.

KWIK-STIK and LYFO DISK

LYFO DISK	KWIK-STIK 6-Pack	KWIK-STIK 2-Pack	Product Description	Price Code	BSL	Comment
0603L	0603K	0603P	Streptococcus dysgalactiae subsp. equisimilis derived from ATCC® 12388™*	C	2	Group C
0602L	0602K	0602P	Streptococcus dysgalactiae subsp. equisimilis derived from ATCC® 12394™*	C	2	Group G
0967L	0967K	0967P	Streptococcus dysgalactiae subsp. equisimilis derived from ATCC® 35666™*	E	2	Group C
0373L	0373K	0373P	Streptococcus dysgalactiae subsp. equisimilis derived from NCTC 8543	E	2	Group C
0221L	0221K	0221P	Streptococcus equi subsp. equi derived from ATCC® 33398™*	C	2	Group C
0656L	0656K	0656P	Streptococcus equi subsp. equi derived from ATCC® 9528™*	C	2	Group C
0101L	0101K	0101P	Streptococcus equi subsp. zooepidemicus derived from ATCC® 43079™*	C	2	
0743L	0743K	0743P	Streptococcus equi subsp. zooepidemicus derived from ATCC® 700400™*	C	2	
0631L	0631K	0631P	Streptococcus gallolyticus derived from ATCC® 49147™*	C	1	
0391L	0391K	0391P	Streptococcus gallolyticus derived from ATCC® 9809™*	C	1	
0949L	0949K	0949P	Streptococcus gallolyticus subsp. gallolyticus derived from ATCC® 49475™*	D	1	
0383L	0383K	0383P	Streptococcus mitis derived from NCIMB 13770	C	2	
0266L	0266K	0266P	Streptococcus mutans derived from ATCC® 25175™*	C	1	
0969L	0969K	0969P	Streptococcus mutans derived from ATCC® 35668™*	C	1	
0423L	0423K	0423P	Streptococcus oralis derived from ATCC® 6249™*	C	2	Formerly Streptococcus mitis
0630L	0630K	0630P	Streptococcus pasteurianus derived from ATCC® 49133™*	C	1	
0865L	0865K	0865P	Streptococcus pneumoniae derived from ATCC® 10015™*	C	2	
0435L	0435K	0435P	Streptococcus pneumoniae derived from ATCC® 27336™*	C	2	
0632L	0632K	0632P	Streptococcus pneumoniae derived from ATCC® 49136™*	C	2	
0633L	0633K	0633P	Streptococcus pneumoniae derived from ATCC® 49150™*	C	2	
0947L	0947K	0947P	Streptococcus pneumoniae derived from ATCC® 49619™*	C	2	Penicillin intermediate by altered penicillin-binding protein; serotype 19F, type 19; CLSI and EUCAST QC strain for Disk Diffusion and MIC Determination
0763L	0763K	0763P	Streptococcus pneumoniae derived from ATCC® 6301™*	C	2	
0380L	0380K	0380P	Streptococcus pneumoniae derived from ATCC® 6303™*	C	2	Mucoid colonies
0447L	0447K	0447P	Streptococcus pneumoniae derived from ATCC® 6305™*	C	2	
0267L	0267K	0267P	Streptococcus pneumoniae derived from ATCC® 700677™*	D	2	



*Look for the ATCC Licensed Derivative® Emblem for all products derived from ATCC® cultures. The ATCC Licensed Derivative Emblem, the ATCC Licenses Derivative Word Mark, and the ATCC Catalog Marks are trademarks of ATCC. Microbiology, Inc. is licensed to use these trademarks and to sell products derived from ATCC® cultures.

KWIK-STIK and LYFO DISK

LYFO DISK	KWIK-STIK 6-Pack	KWIK-STIK 2-Pack	Product Description	Price Code	BSL	Comment
0469L	0469K	0469P	Streptococcus pneumoniae derived from NCIMB 13286	E	2	
0508L	0508K	0508P	Streptococcus pyogenes derived from ATCC® 12344™*	D	2	Group A; type 1
0979L	0979K	0979P	Streptococcus pyogenes derived from ATCC® 12384™*	B	2	Group A; type 3
0385L	0385K	0385P	Streptococcus pyogenes derived from ATCC® 19615™*	B	2	Group A
0994L	0994K	0994P	Streptococcus pyogenes derived from ATCC® 49399™*	B	2	Group A
		0314P	Streptococcus pyogenes derived from NCIMB 13285	C	2	Group A
0237L	0237K	0237P	Streptococcus salivarius derived from ATCC® 13419™*	D	1	
0136L	0136K	0136P	Streptococcus salivarius subsp. thermophilus derived from ATCC® 19258™*	C	1	
0858L	0858K	0858P	Streptococcus sanguinis derived from ATCC® 10556™*	C	2	
0978L	0978K	0978P	Streptococcus species derived from ATCC® 12392™*	D	1	Group F; type 2
0864L	0864K	0864P	Streptococcus species derived from ATCC® 12401™*	C	2	Group B; type 1b
0744L	0744K	0744P	Streptococcus uberis derived from ATCC® 700407™*	D	1	
Streptomyces						
0859L	0859K	0859P	Streptomyces griseus subsp. griseus derived from ATCC® 10137™*	C	1	
Talaromyces						
01238L	01238K	01238P	Talaromyces pinophilus derived from ATCC® 11797™*	D	1	Mold; fungus resistance testing; formerly Penicillium funiculosum
0535L	0535K	0535P	Talaromyces wortmannii derived from ATCC® 32333™*	E	1	Mold; formerly Penicillium variabile
Thermoanaerobacterium						
0728L	0728K	0728P	Thermoanaerobacterium thermosaccharolyticum derived from ATCC® 7956™*	E	1	
Trichophyton						
0442L	0442K	0442P	Trichophyton interdigitale derived from ATCC® 9533™*	E	2	Mold; formerly Trichophyton mentagrophytes
0444L	0444K	0444P	Trichophyton rubrum derived from ATCC® 28188™*	E	2	Mold
0891L	0891K	0891P	Trichophyton tonsurans derived from ATCC® 28942™*	E	2	Mold
Trichosporon						
0778L	0778K	0778P	Trichosporon dermatis derived from ATCC® 204094™*	E	2	Formerly Trichosporon mucoides; yeast cells
Trueperella						
0660L	0660K	0660P	Trueperella pyogenes derived from ATCC® 19411™*	D	2	Formerly Arcanobacterium pyogenes
Ureaplasma						
0151L	0151K	0151P	Ureaplasma parvum derived from ATCC® 27813™*	E	2	
Veillonella						
0867L	0867K	0867P	Veillonella parvula derived from ATCC® 10790™*	E	1	

KWIK-STIK and LYFO DISK

LYFO DISK	KWIK-STIK 6-Pack	KWIK-STIK 2-Pack	Product Description	Price Code	BSL	Comment
Vibrio						
0819L	0819K	0819P	Vibrio alginolyticus derived from ATCC® 17749™*	C	1	
0720L	0720K	0720P	Vibrio furnissii derived from NCTC 11218	C	1	
01236L	01236K	01236P	Vibrio parahaemolyticus (o2:k3) derived from NCTC 10885	E	2	Serovar o2:k3
0818L	0818K	0818P	Vibrio parahaemolyticus derived from ATCC® 17802™*	D	2	
01076L	01076K	01076P	Vibrio vulnificus derived from ATCC® 27562™*	D	2	
01214L	01214K	01214P	Vibrio vulnificus derived from ATCC® 29307™*	E	2	Halophilic; recommended by ISO 11133 for performance testing of culture media
Walleimia						
01141L	01141K	01141P	Walleimia mellicola derived from ATCC® 42694™*	D	1	Mold; formerly Walleimia sebi
Yarrowia						
0950L	0950K	0950P	Yarrowia lipolytica derived from ATCC® 9773™*	D	1	Yeast cells
Yersinia						
0316L	0316K	0316P	Yersinia enterocolitica subsp. enterocolitica derived from ATCC® 23715™*	C	2	Biotype 1; serotype 8
0909L	0909K	0909P	Yersinia enterocolitica subsp. enterocolitica derived from ATCC® 27729™*	C	2	Biotype 1; serotype 8
0938L	0938K	0938P	Yersinia enterocolitica subsp. enterocolitica derived from ATCC® 9610™*	D	2	Biovar 1; serogroup O:8
0974L	0974K	0974P	Yersinia kristensenii derived from ATCC® 33639™*	D	2	
0785L	0785K	0785P	Yersinia ruckeri derived from ATCC® 29473™*	E	1	
Zygosaccharomyces						
01011L	01011K	01011P	Zygosaccharomyces parabaillii derived from ATCC® MYA-4549™*	E	1	Yeast cells
0803L	0803K	0803P	Zygosaccharomyces rouxii derived from ATCC® 28253™*	E	1	Yeast cells
0255L	0255K	0255P	Zygosaccharomyces rouxii derived from NCYC 381	E	1	



*Look for the ATCC Licensed Derivative® Emblem for all products derived from ATCC® cultures. The ATCC Licensed Derivative Emblem, the ATCC Licenses Derivative Word Mark, and the ATCC Catalog Marks are trademarks of ATCC. Microbiologics, Inc. is licensed to use these trademarks and to sell products derived from ATCC® cultures.

Bundled Sets and Panels of
Microorganisms for Assay,
Diagnostic System and Test Kit QC

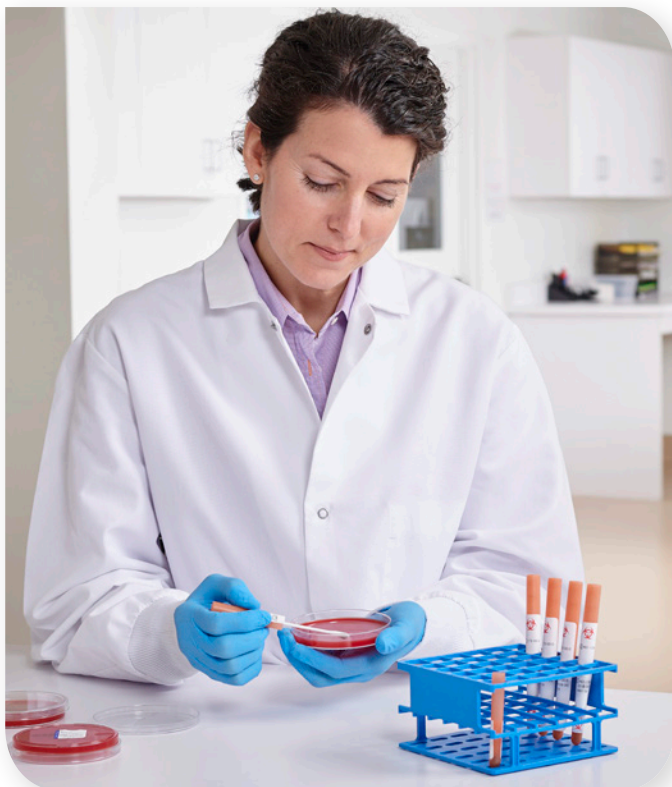

Highlights:

- Each **assay or diagnostic system** QC set or panel contains the manufacturer recommended quality control strains for a particular instrument or test in an easy-to-use format
- Each **regulation-specific** QC set or panel contains the regulation-specific (e.g., CLSI) recommended quality control strains for a particular test in an easy-to-use format
- One simple catalog number for fast, easy ordering
- Protects your reputation by providing documentation and assurance that the laboratory can consistently produce accurate results
- Ensures testing procedures and materials are working properly
- Convenient, test-ready format saves time and money
- Technical Support experts available for guidance

Applications:

- QC of microbial identification and detection instruments and commercial diagnostic assays including biochemical, PCR and molecular technologies
- QC of CLSI® Antimicrobial Susceptibility Testing (AST) and many other common tests
- Verification and Validation
- Proficiency

Package Details:

- Live Culture QC Sets and Panels: KWIK-STIK™ 2-Pack (two KWIK-STIKs of each microorganism)

Visit microbiologics.com to view molecular QC Sets and Panels

Assay and Diagnostic System QC Sets and Panels

Catalog Number	Product Description	Catalog Number	Product Description
5065P	ANA (3 Strains) QC Set <ul style="list-style-type: none"> 0619P <i>Bacteroides uniformis</i> derived from ATCC® 8492™* 0331P <i>Clostridium sordellii</i> derived from ATCC® 9714™* 0618P <i>Parabacteroides distasonis</i> derived from ATCC® 8503™* 	5112P	AST-GP (4 Strains) QC Set <ul style="list-style-type: none"> 0366P <i>Enterococcus faecalis</i> derived from ATCC® 29212™* 0959P <i>Enterococcus faecalis</i> derived from ATCC® 51299™* 0495P <i>Escherichia coli</i> derived from ATCC® 35218™* 0365P <i>Staphylococcus aureus</i> subsp. <i>aureus</i> derived from ATCC® 29213™*
5246P	Anaerobe Identification Panel <ul style="list-style-type: none"> 0358P <i>Bacteroides fragilis</i> derived from NCTC 9343 0329P <i>Clostridioides difficile</i> derived from ATCC® 9689™* 0170P <i>Cutibacterium acnes</i> derived from ATCC® 6919™* 0407P <i>Fusobacterium necrophorum</i> subsp. <i>necrophorum</i> derived from ATCC® 25286™* 0322P <i>Peptostreptococcus anaerobius</i> derived from ATCC® 27337™* 	5184P	AST-YS QC Set <ul style="list-style-type: none"> 0726P <i>Candida parapsilosis</i> derived from ATCC® 22019™* 0227P <i>Issatchenkia orientalis</i> derived from ATCC® 6258™*
5190P	ANC Comprehensive QC Set <ul style="list-style-type: none"> 0585P <i>Bacteroides ovatus</i> derived from ATCC® BAA-1296™* 0445P <i>Bacteroides vulgatus</i> derived from ATCC® 8482™* 0318P <i>Clostridium perfringens</i> derived from ATCC® 13124™* 0586P <i>Clostridium septicum</i> derived from ATCC® 12464™* 0331P <i>Clostridium sordellii</i> derived from ATCC® 9714™* 0583P <i>Corynebacterium striatum</i> derived from ATCC® BAA-1293™* 0584P <i>Parabacteroides distasonis</i> derived from ATCC® BAA-1295™* 	5191P	BCL Comprehensive QC Set <ul style="list-style-type: none"> 0141P <i>Aneurinibacillus aneurinilyticus</i> derived from ATCC® 11376™* 01008P <i>Bacillus badius</i> derived from ATCC® 14574™* 0140P <i>Bacillus circulans</i> derived from ATCC® 61™* 0201P <i>Bacillus megaterium</i> derived from ATCC® 14581™* 0474P <i>Bacillus pumilus</i> derived from ATCC® BAA-1434™* 0139P <i>Brevibacillus agri</i> derived from ATCC® 51663™* 0144P <i>Brevibacillus laterosporus</i> derived from ATCC® 64™* 0306P <i>Klebsiella aerogenes</i> derived from ATCC® 13048™* 0473P <i>Paenibacillus gordonae</i> derived from ATCC® 29948™* 0142P <i>Paenibacillus macerans</i> derived from ATCC® 8509™* 0296P <i>Paenibacillus polymyxa</i> derived from ATCC® 7070™* 0371P <i>Staphylococcus epidermidis</i> derived from ATCC® 12228™*
5216P	ANC Streamlined QC Set <ul style="list-style-type: none"> 0585P <i>Bacteroides ovatus</i> derived from ATCC® BAA-1296™* 0586P <i>Clostridium septicum</i> derived from ATCC® 12464™* 	5188P	Biolog; GEN III MicroPlate QC Set <ul style="list-style-type: none"> 0465P <i>Escherichia coli</i> derived from ATCC® 11775™* 0883P <i>Paenibacillus polymyxa</i> derived from ATCC® 842™* 0371P <i>Staphylococcus epidermidis</i> derived from ATCC® 12228™* 0369P <i>Stenotrophomonas maltophilia</i> derived from ATCC® 13637™*
5189P	AST-GN QC Set with Klebsiella <ul style="list-style-type: none"> 0335P <i>Escherichia coli</i> derived from ATCC® 25922™* 0495P <i>Escherichia coli</i> derived from ATCC® 35218™* 0784P <i>Klebsiella pneumoniae</i> subsp. <i>pneumoniae</i> derived from ATCC® 700603™* 0353P <i>Pseudomonas aeruginosa</i> derived from ATCC® 27853™* 	5244P	Bruker MALDI Biotyper System Comprehensive Identification Panel <ul style="list-style-type: none"> 0486P <i>Bacillus subtilis</i> subsp. <i>spizizenii</i> derived from ATCC® 6633™* 0443P <i>Candida albicans</i> derived from ATCC® 10231™* 0680P <i>Escherichia coli</i> derived from ATCC® 10536™* 0483P <i>Escherichia coli</i> derived from ATCC® 8739™* 0689P <i>Micrococcus luteus</i> derived from ATCC® 10240™* 0484P <i>Pseudomonas aeruginosa</i> derived from ATCC® 9027™* 0485P <i>Staphylococcus aureus</i> subsp. <i>aureus</i> derived from ATCC® 6538™* 0369P <i>Stenotrophomonas maltophilia</i> derived from ATCC® 13637™*
5220P	AST-GP (6 Strains) QC Set <ul style="list-style-type: none"> 0366P <i>Enterococcus faecalis</i> derived from ATCC® 29212™* 0959P <i>Enterococcus faecalis</i> derived from ATCC® 51299™* 0179P <i>Staphylococcus aureus</i> derived from ATCC® BAA-1026™* 0365P <i>Staphylococcus aureus</i> subsp. <i>aureus</i> derived from ATCC® 29213™* 0146P <i>Staphylococcus aureus</i> subsp. <i>aureus</i> derived from ATCC® BAA-976™* 0147P <i>Staphylococcus aureus</i> subsp. <i>aureus</i> derived from ATCC® BAA-977™* 		
5187P	AST-GP (5 Strains) QC Set <ul style="list-style-type: none"> 0366P <i>Enterococcus faecalis</i> derived from ATCC® 29212™* 0179P <i>Staphylococcus aureus</i> derived from ATCC® BAA-1026™* 0365P <i>Staphylococcus aureus</i> subsp. <i>aureus</i> derived from ATCC® 29213™* 0146P <i>Staphylococcus aureus</i> subsp. <i>aureus</i> derived from ATCC® BAA-976™* 0147P <i>Staphylococcus aureus</i> subsp. <i>aureus</i> derived from ATCC® BAA-977™* 		

Assay and Diagnostic System QC Sets and Panel

Catalog Number	Product Description	Catalog Number	Product Description
5245P	Bruker MALDI Biotyper System Extended Identification Panel (IQ/OQ) <ul style="list-style-type: none">0120P <i>Bacillus subtilis</i> subsp. <i>subtilis</i> derived from ATCC® 6051™*01167P <i>Brevundimonas vesicularis</i> derived from ATCC® 11426™*01186P <i>Chryseobacterium indologenes</i> derived from ATCC® 29897™*01044P <i>Curtobacterium pusillum</i> derived from ATCC® 19096™*01184P <i>Deinococcus radiophilus</i> derived from ATCC® 27603™*0367P <i>Enterococcus faecalis</i> derived from ATCC® 19433™*01181P <i>Methylobacterium organophilum</i> derived from ATCC® 27886™*0242P <i>Micrococcus luteus</i> derived from ATCC® 4698™*01152P <i>Proteus vulgaris</i> derived from ATCC® 29905™*0416P <i>Pseudomonas aeruginosa</i> derived from ATCC® 10145™*01159P <i>Ralstonia pickettii</i> derived from ATCC® 27511™*0274P <i>Sphingomonas paucimobilis</i> derived from ATCC® 29837™*0173P <i>Staphylococcus aureus</i> subsp. <i>aureus</i> derived from ATCC® 12600™*0412P <i>Staphylococcus epidermidis</i> derived from ATCC® 14990™*0369P <i>Stenotrophomonas maltophilia</i> derived from ATCC® 13637™*	5227P	Charles River Axxess System Qualification Panel <ul style="list-style-type: none">0120P <i>Bacillus subtilis</i> subsp. <i>subtilis</i> derived from ATCC® 6051™*01167P <i>Brevundimonas vesicularis</i> derived from ATCC® 11426™*0332P <i>Candida albicans</i> derived from ATCC® 14053™*01186P <i>Chryseobacterium indologenes</i> derived from ATCC® 29897™*01044P <i>Curtobacterium pusillum</i> derived from ATCC® 19096™*01184P <i>Deinococcus radiophilus</i> derived from ATCC® 27603™*0367P <i>Enterococcus faecalis</i> derived from ATCC® 19433™*01181P <i>Methylobacterium organophilum</i> derived from ATCC® 27886™*0242P <i>Micrococcus luteus</i> derived from ATCC® 4698™*01152P <i>Proteus vulgaris</i> derived from ATCC® 29905™*0416P <i>Pseudomonas aeruginosa</i> derived from ATCC® 10145™*01159P <i>Ralstonia pickettii</i> derived from ATCC® 27511™*0173P <i>Staphylococcus aureus</i> subsp. <i>aureus</i> derived from ATCC® 12600™*0412P <i>Staphylococcus epidermidis</i> derived from ATCC® 14990™*0369P <i>Stenotrophomonas maltophilia</i> derived from ATCC® 13637™*
5209P	CBC QC Set <ul style="list-style-type: none">01038P <i>Arcanobacterium haemolyticum</i> derived from ATCC® BAA-1784™*01046P <i>Cellulosimicrobium cellulans</i> derived from ATCC® BAA-1816™*01047P <i>Cellulosimicrobium cellulans</i> derived from ATCC® BAA-1817™*01040P <i>Corynebacterium renale</i> derived from ATCC® BAA-1785™*01039P <i>Corynebacterium urealyticum</i> derived from ATCC® 43044™*01044P <i>Curtobacterium pusillum</i> derived from ATCC® 19096™*0757P <i>Klebsiella oxytoca</i> derived from ATCC® 700324™*01042P <i>Microbacterium liquefaciens</i> derived from ATCC® BAA-1819™*01041P <i>Microbacterium paraoxydans</i> derived from ATCC® BAA-1818™*0295P <i>Microbacterium testaceum</i> derived from ATCC® 15829™*0132P <i>Ochrobactrum anthropi</i> derived from ATCC® BAA-749™*	5144P	Colilert® QC Set <ul style="list-style-type: none">0465P <i>Escherichia coli</i> derived from ATCC® 11775™*0261P <i>Klebsiella variicola</i> derived from ATCC® 31488™*0416P <i>Pseudomonas aeruginosa</i> derived from ATCC® 10145™*
		5062P	Dried Overnight – Gram Negative Panel QC Set <ul style="list-style-type: none">0335P <i>Escherichia coli</i> derived from ATCC® 25922™*0495P <i>Escherichia coli</i> derived from ATCC® 35218™*0626P <i>Klebsiella oxytoca</i> derived from ATCC® 49131™*0784P <i>Klebsiella pneumoniae</i> subsp. <i>pneumoniae</i> derived from ATCC® 700603™*0640P <i>Proteus vulgaris</i> derived from ATCC® 49132™*0353P <i>Pseudomonas aeruginosa</i> derived from ATCC® 27853™*
		5063P	Dried Overnight – Gram Positive Panel QC Set <ul style="list-style-type: none">0366P <i>Enterococcus faecalis</i> derived from ATCC® 29212™*0495P <i>Escherichia coli</i> derived from ATCC® 35218™*0804P <i>Micrococcus luteus</i> derived from ATCC® 49732™*0365P <i>Staphylococcus aureus</i> subsp. <i>aureus</i> derived from ATCC® 29213™*0852P <i>Staphylococcus aureus</i> subsp. <i>aureus</i> derived from ATCC® 43300™*0147P <i>Staphylococcus aureus</i> subsp. <i>aureus</i> derived from ATCC® BAA-977™*0631P <i>Streptococcus gallolyticus</i> derived from ATCC® 49147™*

Assay and Diagnostic System QC Sets and Panels

Catalog Number	Product Description	Catalog Number	Product Description
5192P	GN Comprehensive QC Set <ul style="list-style-type: none">0119P <i>Acinetobacter baumannii</i> derived from ATCC® BAA-747™*0971P <i>Elizabethkingia meningoseptica</i> derived from ATCC® 13253™*0755P <i>Enterobacter hormaechei</i> derived from ATCC® 700323™*0335P <i>Escherichia coli</i> derived from ATCC® 25922™*0757P <i>Klebsiella oxytoca</i> derived from ATCC® 700324™*0132P <i>Ochrobactrum anthropi</i> derived from ATCC® BAA-749™*01009P <i>Pseudomonas aeruginosa</i> derived from ATCC® 9721™*01010P <i>Pseudomonas aeruginosa</i> derived from ATCC® BAA-1744™*0459P <i>Proteus vulgaris</i> derived from ATCC® 6380™*0759P <i>Stenotrophomonas maltophilia</i> derived from ATCC® 17666™*	5066P	NH (3 Strains) QC Set <ul style="list-style-type: none">0645P <i>Aggregatibacter aphrophilus</i> derived from ATCC® 49146™*0620P <i>Haemophilus influenzae</i> derived from ATCC® 9006™*0622P <i>Moraxella catarrhalis</i> derived from ATCC® 8176™*0621P <i>Oligella urethralis</i> derived from ATCC® 17960™*
5193P	GP Comprehensive QC Set <ul style="list-style-type: none">0761P <i>Enterococcus casseliflavus</i> derived from ATCC® 700327™*0223P <i>Enterococcus saccharolyticus</i> derived from ATCC® 43076™*0126P <i>Kocuria kristinae</i> derived from ATCC® BAA-752™*0130P <i>Listeria monocytogenes</i> derived from ATCC® BAA-751™*0134P <i>Staphylococcus saprophyticus</i> derived from ATCC® BAA-750™*0764P <i>Staphylococcus sciuri</i> subsp. <i>sciuri</i> derived from ATCC® 29061™*0101P <i>Streptococcus equi</i> subsp. <i>zooepidemicus</i> derived from ATCC® 43079™*0947P <i>Streptococcus pneumoniae</i> derived from ATCC® 49619™*0136P <i>Streptococcus salivarius</i> subsp. <i>thermophilus</i> derived from ATCC® 19258™*	5194P	NH Comprehensive QC Set <ul style="list-style-type: none">0184P <i>Aggregatibacter aphrophilus</i> derived from ATCC® 33389™*0189P <i>Eikenella corrodens</i> derived from ATCC® BAA-1152™*0185P <i>Haemophilus influenzae</i> derived from ATCC® 9007™*0306P <i>Klebsiella aerogenes</i> derived from ATCC® 13048™*0378P <i>Neisseria gonorrhoeae</i> derived from ATCC® 19424™*0405P <i>Neisseria lactamica</i> derived from ATCC® 23970™*0621P <i>Oligella urethralis</i> derived from ATCC® 17960™*0296P <i>Paenibacillus polymyxa</i> derived from ATCC® 7070™*0371P <i>Staphylococcus epidermidis</i> derived from ATCC® 12228™*
5215P	GP Streamlined QC Set <ul style="list-style-type: none">0761P <i>Enterococcus casseliflavus</i> derived from ATCC® 700327™*0134P <i>Staphylococcus saprophyticus</i> derived from ATCC® BAA-750™*	5107P	Non-Fastidious Gram Negative (5 Strains) QC Set <ul style="list-style-type: none">0323P <i>Enterobacter cloacae</i> subsp. <i>cloacae</i> derived from ATCC® 13047™*0335P <i>Escherichia coli</i> derived from ATCC® 25922™*0942P <i>Klebsiella pneumoniae</i> subsp. <i>pneumoniae</i> derived from ATCC® 35657™*0944P <i>Proteus mirabilis</i> derived from ATCC® 35659™*0742P <i>Stenotrophomonas maltophilia</i> derived from ATCC® 51331™*
5247P	Gram Negative Identification Panel <ul style="list-style-type: none">0574P <i>Citrobacter freundii</i> derived from NCTC 97500465P <i>Escherichia coli</i> derived from ATCC® 11775™*0351P <i>Klebsiella pneumoniae</i> subsp. <i>pneumoniae</i> derived from ATCC® 13883™*0598P <i>Pseudomonas aeruginosa</i> derived from NCIMB 12469<i>Yersinia enterocolitica</i> derived from NCTC 11174	5252P	Yeast Identification Panel <ul style="list-style-type: none">0379P <i>Candida albicans</i> derived from NCYC 13630992P <i>Candida glabrata</i> derived from ATCC® 2001™*0726P <i>Candida parapsilosis</i> derived from ATCC® 22019™*01051P <i>Cryptococcus gattii</i> derived from ATCC® MYA-4560™*0736P <i>Saccharomyces cerevisiae</i> derived from NCYC 79
5248P	Gram Positive Identification Panel <ul style="list-style-type: none">01108P <i>Corynebacterium jeikeium</i> derived from ATCC® 43734™*0472P <i>Enterococcus faecalis</i> derived from NCTC 7750242P <i>Micrococcus luteus</i> derived from ATCC® 4698™*0571P <i>Staphylococcus epidermidis</i> derived from NCIMB 88530469P <i>Streptococcus pneumoniae</i> derived from NCIMB 13286	5195P	YST Comprehensive QC Set <ul style="list-style-type: none">0332P <i>Candida albicans</i> derived from ATCC® 14053™*0122P <i>Candida glabrata</i> derived from ATCC® MYA-2950™*0774P <i>Candida lusitanae</i> derived from ATCC® 34449™*0779P <i>Candida utilis</i> derived from ATCC® 9950™*01012P <i>Hanseniaspora valbyensis</i> derived from ATCC® 58370™*0868P <i>Oligella ureolytica</i> derived from ATCC® 43534™*0780P <i>Prototheca wickerhamii</i> derived from ATCC® 16529™*01013P <i>Sporidiobolus salmonicolor</i> derived from ATCC® MYA-4550™*0371P <i>Staphylococcus epidermidis</i> derived from ATCC® 12228™*0778P <i>Trichosporon dermatis</i> derived from ATCC® 204094™*01011P <i>Zygosaccharomyces parabaillii</i> derived from ATCC® MYA-4549™*

Regulation-Specific QC Sets and Panels

Catalog Number	Product Description
5002P	CLSI®; MIC QC Set without Klebsiella pneumoniae <ul style="list-style-type: none">• 0366P Enterococcus faecalis derived from ATCC® 29212™*• 0335P Escherichia coli derived from ATCC® 25922™*• 0495P Escherichia coli derived from ATCC® 35218™*• 0353P Pseudomonas aeruginosa derived from ATCC® 27853™*• 0365P Staphylococcus aureus subsp. aureus derived from ATCC® 29213™*
5027P	CLSI® M22; Chocolate Agar QC Set <ul style="list-style-type: none">• 0441P Haemophilus influenzae derived from ATCC® 10211™*• 0429P Neisseria gonorrhoeae derived from ATCC® 43069™*



*Look for the ATCC Licensed Derivative® Emblem for all products derived from ATCC® cultures. The ATCC Licensed Derivative Emblem, the ATCC Licenses Derivative Word Mark, and the ATCC Catalog Marks are trademarks of ATCC. Microbiologics, Inc. is licensed to use these trademarks and to sell products derived from ATCC® cultures.

Food and Cannabis QC Sets and Panels

Catalog Number	Product Description
5218P	Big 6 STEC QC Set - Export License Required** <ul style="list-style-type: none">• 01101P Escherichia coli serotype O103:H11 derived from CDC 06-3008 (STEC)• 01102P Escherichia coli serotype O111:H8 derived from CDC 2010C-3114 (STEC)• 01099P Escherichia coli serotype O121:H19 derived from CDC 02-3211 (STEC)• 01097P Escherichia coli serotype O145:NM derived from CDC 99-3311 (STEC)• 01100P Escherichia coli serotype O26:H11 derived from CDC 03-3014 (STEC)• 01098P Escherichia coli serotype O45:H2 derived from CDC 00-3039 (STEC)
5219P	Big 7 STEC QC Set - Export License Required** <ul style="list-style-type: none">• 01101P Escherichia coli serotype O103:H11 derived from CDC 06-3008 (STEC)• 01102P Escherichia coli serotype O111:H8 derived from CDC 2010C-3114 (STEC)• 01099P Escherichia coli serotype O121:H19 derived from CDC 02-3211 (STEC)• 01097P Escherichia coli serotype O145:NM derived from CDC 99-3311 (STEC)• 0617P Escherichia coli serotype O157:H7 derived from ATCC® 35150™* (STEC)• 01100P Escherichia coli serotype O26:H11 derived from CDC 03-3014 (STEC)• 01098P Escherichia coli serotype O45:H2 derived from CDC 00-3039 (STEC)
5254P	Bruker MALDI Biotyper System Food Identification Panel <ul style="list-style-type: none">• 0229P Citrobacter freundii derived from ATCC® 43864™*• 0366P Enterococcus faecalis derived from ATCC® 29212™*• 0128P Lactobacillus sakei subsp. sakei derived from ATCC® 15521™*• 0699P Saccharomyces cerevisiae derived from ATCC® 9763™*• 0605P Staphylococcus xylosum derived from ATCC® 29971™*
5255P	Bruker MALDI Biotyper System Food Pathogens Identification Panel <ul style="list-style-type: none">• 0481P Campylobacter jejuni subsp. jejuni derived from ATCC® 33291™*• 01088P Cronobacter sakazakii derived from ATCC® 29544™*• 0129P Listeria monocytogenes derived from ATCC® 13932™*• 0363P Salmonella enterica subsp. enterica serovar Typhimurium derived from ATCC® 14028™*
5257P	Cannabis Process Control QC Set** <ul style="list-style-type: none">• 01021P Aspergillus fumigatus derived from ATCC® 204305™*• 0617P Escherichia coli (O157:H7) derived from ATCC® 35150™* (STEC)• 0363P Salmonella enterica subsp. enterica serovar Typhimurium derived from ATCC® 14028™*
5256P	Complete Aspergillus Collection for Cannabis Process Control QC Set <ul style="list-style-type: none">• 0245P Aspergillus niger derived from ATCC® 16888™*• 01021P Aspergillus fumigatus derived from ATCC® 204305™*• 01182P Aspergillus flavus derived from ATCC® 9643™*• 01264P Aspergillus terreus derived from ATCC® 1012™*

**Export license required for shipping this product outside the United States. Contact Customer Service with questions: 1.320.253.1640 or info@microbiologics.com

Visit [microbiologics.com](https://www.microbiologics.com) for molecular QC Sets and Panels



*Look for the ATCC Licensed Derivative® Emblem for all products derived from ATCC® cultures. The ATCC Licensed Derivative Emblem, the ATCC Licenses Derivative Word Mark, and the ATCC Catalog Marks are trademarks of ATCC. Microbiologics, Inc. is licensed to use these trademarks and to sell products derived from ATCC® cultures.

PARASITE SUSPENSIONS

Simple, Reliable QC Testing
for Parasitology Diagnostic
Kits and Methods



Highlights:

- Convenient, test-ready format saves time and money
- Designed to mimic a patient sample for simple control processing
- Includes a Certificate of Performance that provides a detailed description of the specimen
- Online Certificate of Analysis provides detailed strain information
- FDA listed and CE Marked as an *In Vitro* Diagnostic (IVD) Medical Device
- Convenient and economical room temperature storage and two year shelf life
- **WARNING:** Cancer and reproductive harm - www.P65Warnings.ca.gov

Applications:

- QC of diagnostic test kits and methods
- Microscopic examinations
- Acid-fast staining procedures
- Proficiency tests
- Education

Package Details:

- Vial containing a 1 ml suspension of parasite species
- Instructions for Use
- Certificate of Performance

1

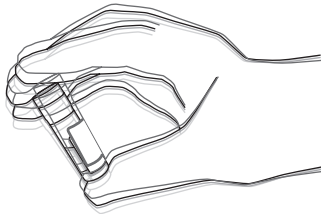

Thoroughly mix the suspension by vigorously shaking or vortexing.

2

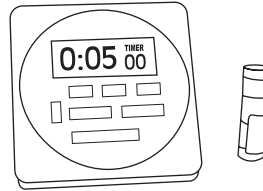

Allow the suspension to settle for 5-10 minutes before use in any testing procedure.

3

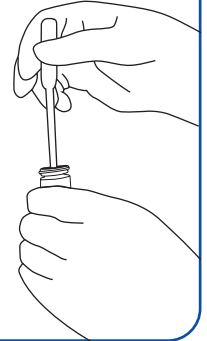

Carefully insert a pipette into the bottom of the vial and remove a single drop for testing. Consult laboratory SOPs, stain, or kit manufacturer instructions for testing procedures.

Parasite Suspensions

Catalog Number	Product Description	Comments
FP05	Ascaris lumbricoides Parasite Suspension	Fecal suspension containing Ascaris lumbricoides eggs fixed in formalin
FP02	Cryptosporidium species Parasite Suspension	Fecal suspension containing Cryptosporidium oocysts fixed in formalin
FP03	Diphyllobothrium latum Parasite Suspension	Fecal suspension containing Diphyllobothrium latum eggs fixed in formalin
FP12	Endolimax nana Parasite Suspension	Fecal suspension containing Endolimax nana cysts fixed in formalin
FP13	Entamoeba coli Parasite Suspension	Fecal suspension containing Entamoeba coli cysts fixed in formalin
FP01	Giardia lamblia Parasite Suspension	Fecal suspension containing Giardia lamblia cysts fixed in formalin
FP11	Hymenolepis nana Parasite Suspension	Fecal suspension containing Hymenolepis nana eggs fixed in formalin
FP09	Iodamoeba butschlii Parasite Suspension	Fecal suspension containing Iodamoeba butschlii cysts fixed in formalin
FP10	Necator americanus Parasite Suspension	Fecal suspension containing Necator americanus eggs fixed in formalin
FP06	Strongyloides stercoralis Parasite Suspension	Fecal suspension containing Strongyloides stercoralis larvae fixed in formalin
FP04	Taenia species Parasite Suspension	Fecal suspension containing Taenia eggs fixed in formalin
FP08	Trichuris trichiura Parasite Suspension	Fecal suspension containing Trichuris trichiura eggs fixed in formalin

WARNING: Cancer and reproductive harm - www.P65Warnings.ca.gov

QC MICROBIOLOGY SLIDES

Microbiology Slides for QC of Microscopic Examinations



Highlights:

- Convenient, test-ready format saves time and money
- Room temperature storage is easy and economical
- FDA listed and CE Marked as an *In Vitro* Diagnostic (IVD) Medical Device
- Online Certificate of Analysis provides detailed strain information
- Technical Support experts available for guidance

Applications:

- Acid-fast stain controls
- Blood parasites
- Tissue parasites
- Intestinal parasites
- Gram stain controls
- Mycology controls
- Proficiency
- Education

Package Details:

- Box of ten slides
- Each slide contains droplets of an air-dried, fixed and preserved organism, or a smear
- Instructions for Use



QC Microbiology Slides

Catalog Number	Product Description
SL40-10	Acid Fast Control Slide This quality control slide provides two air-dried and methanol-fixed droplets within two etched circles. The circle nearest the label contains a droplet of an Acid Fast-Positive Mycobacterium gordonae derived from ATCC® 14470™*. The circle farthest from the label contains a droplet of an Acid Fast-Positive Cryptosporidium in a fecal sample and also contains Acid Fast-Negative intestinal bacteria.
SL90-10	Blood Parasite Control Slide This quality control slide provides an air-dried, methanol-fixed, blood parasite smear containing Plasmodium, Babesia or Trypanosoma.
SL45-10	Cryptosporidium Control Slide This quality control slide provides a single, air-dried and methanol-fixed fecal smear containing Acid Fast-Positive Cryptosporidium and Acid Fast-Negative intestinal bacteria.
SL50-10	FYC (Culture Isolates) Control Slide This quality control slide provides a single, air-dried and methanol-fixed preparation containing Candida albicans derived from ATCC® 10231™*.
SL01-10	Gram Stain Control Slide This quality control slide provides two air-dried and methanol-fixed droplets within two etched circles. The circle nearest the label contains a droplet of Gram-Positive Staphylococcus aureus derived from ATCC® 25923™*. The circle farthest from the label contains a droplet of a Gram-Negative Escherichia coli derived from ATCC® 25922™*.
SL60-10	MYC-D (Clinical Samples) Control Slide This quality control slide provides a single, air-dried and methanol-fixed preparation containing Candida albicans derived from ATCC® 10231™* with Leucocytes and Erythrocytes.
SL41-10	Mycobacterium Control Slide This quality control slide provides two air-dried and methanol-fixed droplets within two etched circles. The circle nearest the label contains an Acid Fast-Positive Mycobacterium gordonae derived from ATCC® 14470™* and the circle farthest from the label contains an Acid Fast-Negative Erysipelothrix rhusiopathiae derived from ATCC® 19414™*.
SL70-10	Pneumocystis carinii Control Slide This quality control slide provides a single, air-dried and methanol-fixed rat lung tissue preparation containing Pneumocystis.
SL75-10	Pneumocystis carinii Two-Well Control Slide This quality control slide provides two, air-dried and methanol-fixed impression smears within two etched circles. One sample contains a rat lung tissue preparation that is positive for Pneumocystis carinii. The other sample contains a rat lung tissue preparation that is negative for Pneumocystis carinii.
SL15-10	SAF-Preserved Fecal Smear Control This quality control slide provides an air-dried, SAF preserved, fecal smear containing a representative intestinal protozoa, usually Giardia lamblia.
SL10-10	Zinc PVA-Preserved Fecal Smear Control This quality control slide provides an air-dried, Zinc PVA-preserved, fecal smear containing a representative intestinal protozoa, usually Giardia lamblia.

Lab-Elite™

CERTIFIED REFERENCE MATERIAL

Qualitative QC Microorganisms Classified as Certified Reference Material to Meet ISO 17025 Requirements



Highlights:

- Qualitative QC microorganisms one passage from the reference strain for ultimate authenticity
- For testing laboratories, Section 6.5.2 of ISO 17025:2017 states: “The laboratory shall ensure that measurement results are traceable to the International System of Units (SI) through: b) certified values of certified reference materials provided by a competent producer with stated metrological traceability to the SI...”
- FDA listed and CE Marked as an *In Vitro* Diagnostic (IVD) Medical Device
- Ready-to-use format saves time and money
- Refrigerated storage is easy and economical
- Online Certificate of Analysis provides detailed strain information
- Traceability to reference cultures ensures authenticity
- Technical Support experts available for guidance

Applications:

- Verification and Validation
- Presence/absence
- Identification methods
- ISO 17025 laboratories requiring CRM

Package Details:

- One KWIK-STIK™ – all-in-one design includes a lyophilized microorganism pellet, ampoule of hydrating fluid and inoculating swab
- Certificate of Analysis
- Instructions for Use



ILLUSTRATED INSTRUCTIONS

1

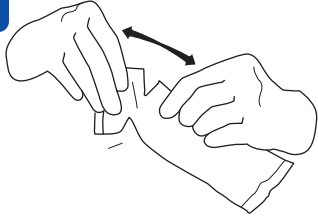

Allow the unopened Lab-Elite™ (KWIK-STIK™) pouch to equilibrate to room temperature. Tear open pouch at notch and remove the KWIK-STIK unit.

2

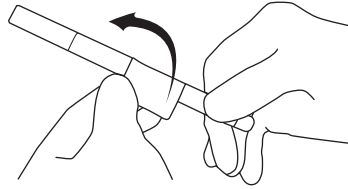

Tear off Pull-Tab portion on the label and attach it to primary culture plate or QC record. Do not disassemble the device during hydration.

3

Over the edge of the work bench or counter, crack the ampoule at the top of the KWIK-STIK (just below the fluid meniscus of the ampoule) found in the cap to release the hydrating fluid.

4

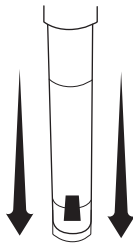

Hold vertically and tap on a hard surface to facilitate flow of fluid through shaft into bottom of unit containing pellet. Allow the hydrating fluid to flow through the swab shaft and into the bottom portion of the unit containing the pellet.

5

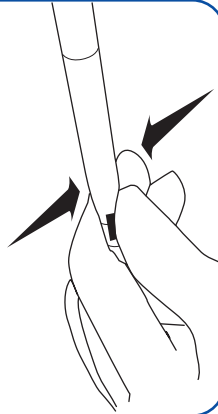

Using a pinching action on the bottom portion of the unit, crush the pellet in the fluid until the pellet suspension is homogenous.

6

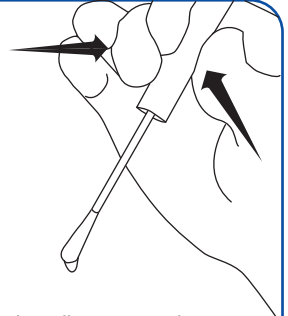

Immediately heavily saturate the swab with the hydrated material and transfer to agar medium.

7

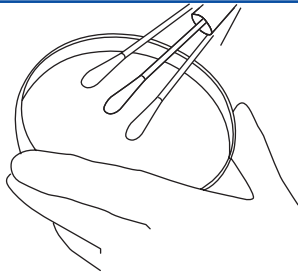

Inoculate the primary culture plate(s) by gently rolling the swab over one-third of the plate.

8

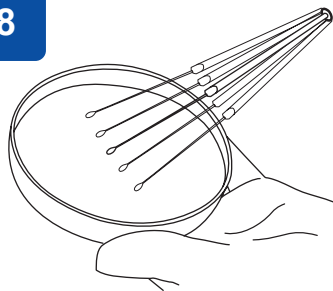

Using a sterile loop, streak to facilitate colony isolation.

9



Using proper biohazard disposal, discard the KWIK-STIK.

10

Immediately incubate the inoculated primary culture plate(s) at temperature and conditions appropriate to the microorganism.

Lab-Elite CRM

Catalog Number	Product Description	BSL	Comment
0789-CRM	<i>Actinobacillus pleuropneumoniae</i> derived from ATCC® 27090™*	2	
0263-CRM	<i>Aerococcus viridans</i> derived from ATCC® 10400™*	1	
0392-CRM	<i>Aspergillus brasiliensis</i> derived from ATCC® 16404™*	1	Mold
01021-CRM	<i>Aspergillus fumigatus</i> derived from ATCC® 204305™*	2	Mold
0998-CRM	<i>Bacillus cereus</i> derived from ATCC® 10876™*	1	
0200-CRM	<i>Bacillus cereus</i> derived from ATCC® 14579™*	1	
0256-CRM	<i>Bacillus cereus</i> derived from ATCC®11778™*	1	
0486-CRM	<i>Bacillus subtilis</i> subsp. <i>spizizenii</i> derived from ATCC® 6633™*	1	
0320-CRM	<i>Bacteroides fragilis</i> derived from ATCC® 25285™*	2	Beta-lactamase positive CLSI QC strain for Anaerobic Antimicrobial Susceptibility Testing
0144-CRM	<i>Brevibacillus laterosporus</i> derived from ATCC® 64™*	1	
0805-CRM	<i>Brevundimonas diminuta</i> derived from ATCC® 19146™*	1	
0488-CRM	<i>Burkholderia cepacia</i> derived from ATCC® 25416™*	2	
0121-CRM	<i>Campylobacter coli</i> derived from ATCC® 43478™*	2	
01237-CRM	<i>Campylobacter fetus</i> subsp. <i>fetus</i> derived from ATCC® 27374™*	2	Quality Control Strain for FDA Bacteriological Analytical Manual
0481-CRM	<i>Campylobacter jejuni</i> subsp. <i>jejuni</i> derived from ATCC® 33291™*	2	
0111-CRM	<i>Campylobacter jejuni</i> subsp. <i>jejuni</i> derived from ATCC® 33560™*	2	
01132-CRM	<i>Campylobacter lari</i> derived from ATCC® 35221™*	1	
0443-CRM	<i>Candida albicans</i> derived from ATCC® 10231™*	1	Yeast cells
0315-CRM	<i>Citrobacter freundii</i> derived from ATCC® 8090™*	1	
0318-CRM	<i>Clostridium perfringens</i> derived from ATCC® 13124™*	2	
0487-CRM	<i>Clostridium sporogenes</i> derived from ATCC® 11437™*	1	
0317-CRM	<i>Clostridium sporogenes</i> derived from ATCC® 19404™*	1	
01088-CRM	<i>Cronobacter sakazakii</i> derived from ATCC® 29544™*	1	
0323-CRM	<i>Enterobacter cloacae</i> subsp. <i>cloacae</i> derived from ATCC® 13047™*	1	
0367-CRM	<i>Enterococcus faecalis</i> derived from ATCC® 19433™*	2	
0366-CRM	<i>Enterococcus faecalis</i> derived from ATCC® 29212™*	2	
0968-CRM	<i>Enterococcus faecium</i> derived from ATCC® 35667™*	2	
0795-CRM	<i>Escherichia coli</i> (O157:H7) derived from ATCC® 43888™*	2	Serotype O157:H7; does not produce Shiga-Like Toxin I or II
0681-CRM	<i>Escherichia coli</i> derived from ATCC® 11229™*	1	
0335-CRM	<i>Escherichia coli</i> derived from ATCC® 25922™*	1	
01079-CRM	<i>Escherichia coli</i> derived from ATCC® 35401™*	2	Serotype O78:H11
0483-CRM	<i>Escherichia coli</i> derived from ATCC® 8739™*	1	
0441-CRM	<i>Haemophilus influenzae</i> derived from ATCC® 10211™*	2	Type b; beta lactamase negative
0306-CRM	<i>Klebsiella aerogenes</i> derived from ATCC® 13048™*	1	Formerly <i>Enterobacter aerogenes</i>



*Look for the ATCC Licensed Derivative® Emblem for all products derived from ATCC® cultures. The ATCC Licensed Derivative Emblem, the ATCC Licenses Derivative Word Mark, and the ATCC Catalog Marks are trademarks of ATCC. Microbiology, Inc. is licensed to use these trademarks and to sell products derived from ATCC® cultures.

Lab-Elite CRM

Catalog Number	Product Description	BSL	Comment
0351-CRM	<i>Klebsiella pneumoniae</i> subsp. <i>pneumoniae</i> derived from ATCC® 13883™*	2	Methyl Red positive; Voges-Proskauer negative; not thermotolerant
0942-CRM	<i>Klebsiella pneumoniae</i> subsp. <i>pneumoniae</i> derived from ATCC® 35657™*	2	
0261-CRM	<i>Klebsiella variicola</i> derived from ATCC® 31488™*	2	Formerly <i>Klebsiella pneumoniae</i> subsp. <i>pneumoniae</i> ; thermotolerant
0688-CRM	<i>Kocuria rhizophila</i> derived from ATCC® 9341™*	1	
0813-CRM	<i>Lactobacillus fermentum</i> derived from ATCC® 9338™*	1	
0128-CRM	<i>Lactobacillus sakei</i> subsp. <i>sakei</i> derived from ATCC® 15521™*	1	
0814-CRM	<i>Listeria innocua</i> derived from ATCC® 33090™*	1	Serotype 6a
0815-CRM	<i>Listeria ivanovii</i> subsp. <i>ivanovii</i> derived from ATCC® 19119™*	2	
0299-CRM	<i>Listeria ivanovii</i> subsp. <i>londoniensis</i> derived from ATCC® BAA-139™*	1	Formerly <i>Listeria ivanovii</i> subsp. <i>ivanovii</i>
0727-CRM	<i>Listeria monocytogenes</i> derived from ATCC® 15313™*	2	Non-hemolytic on sheep blood agar
0277-CRM	<i>Listeria monocytogenes</i> derived from ATCC® 19111™*	2	Serotype 1
0687-CRM	<i>Listeria monocytogenes</i> derived from ATCC® 19115™*	2	Serotype 4b
0802-CRM	<i>Listeria seeligeri</i> derived from ATCC® 35967™*	1	
0816-CRM	<i>Listeria welshimeri</i> derived from ATCC® 35897™*	1	
0689-CRM	<i>Micrococcus luteus</i> derived from ATCC® 10240™*	1	
0668-CRM	<i>Pasteurella multocida</i> subsp. <i>multocida</i> derived from ATCC® 12945™*	2	
0322-CRM	<i>Peptostreptococcus anaerobius</i> derived from ATCC® 27337™*	1	
0703-CRM	<i>Pluralibacter gergoviae</i> derived from ATCC® 33028™*	2	Formerly <i>Enterobacter gergoviae</i>
0944-CRM	<i>Proteus mirabilis</i> derived from ATCC® 35659™*	2	
0691-CRM	<i>Proteus vulgaris</i> derived from ATCC® 8427™*	2	
0693-CRM	<i>Pseudomonas aeruginosa</i> derived from ATCC® 15442™*	2	Pyocyanin not produced
0353-CRM	<i>Pseudomonas aeruginosa</i> derived from ATCC® 27853™*	2	Microbiologics does not recommend the use of this strain for testing Ceftriaxone using the disk diffusion method - we have found that this strain is displaying resistance to Ceftriaxone using this method
0484-CRM	<i>Pseudomonas aeruginosa</i> derived from ATCC® 9027™*	2	
0697-CRM	<i>Rhodococcus equi</i> derived from ATCC® 6939™ *	2	
0699-CRM	<i>Saccharomyces cerevisiae</i> derived from ATCC® 9763™*	1	Yeast cells
01054-CRM	<i>Salmonella enterica</i> subsp. <i>diarizonae</i> derived from ATCC® 12325™*	2	Lactose broth positive; H2S positive
01045-CRM	<i>Salmonella enterica</i> subsp. <i>diarizonae</i> derived from ATCC® 29934™*	2	Lactose broth positive; H2S negative
0817-CRM	<i>Salmonella enterica</i> subsp. <i>enterica</i> serovar <i>Abaetetuba</i> derived from ATCC® 35640™*	2	
0890-CRM	<i>Salmonella enterica</i> subsp. <i>enterica</i> serovar <i>Abony</i> derived from NCTC 6017	2	Serovar Abony



*Look for the ATCC Licensed Derivative® Emblem for all products derived from ATCC® cultures. The ATCC Licensed Derivative Emblem, the ATCC Licenses Derivative Word Mark, and the ATCC Catalog Marks are trademarks of ATCC. Microbiologics, Inc. is licensed to use these trademarks and to sell products derived from ATCC® cultures.

Lab-Elite CRM

Catalog Number	Product Description	BSL	Comment
01056-CRM	Salmonella enterica subsp. enterica serovar Bispebjerg derived from ATCC® 9842™*	2	H2S negative; formerly Salmonella Abortusequi
0902-CRM	Salmonella enterica subsp. enterica serovar Choleraesuis derived from ATCC® 10708™*	2	Group C1; H2S negative
0343-CRM	Salmonella enterica subsp. enterica serovar Choleraesuis derived from ATCC® 7001™*	2	Group C H2S negative
0345-CRM	Salmonella enterica subsp. enterica serovar Enteritidis derived from ATCC® 13076™*	2	Group D
0604-CRM	Salmonella enterica subsp. enterica serovar Pullorum derived from ATCC® 13036™*	2	H2S negative
0421-CRM	Salmonella enterica subsp. enterica serovar Typhimurium derived from ATCC® 13311™*	2	
0363-CRM	Salmonella enterica subsp. enterica serovar Typhimurium derived from ATCC® 14028™*	2	
0262-CRM	Serratia marcescens derived from ATCC® 43862™*	1	
0356-CRM	Shigella flexneri (2b) derived from ATCC® 12022™*	2	Serotype 2b; group B
0360-CRM	Staphylococcus aureus subsp. aureus derived from ATCC® 25923™*	2	mecA negative; CAMP Test control
0496-CRM	Staphylococcus aureus subsp. aureus derived from ATCC® 33591™*	2	Methicillin resistant
0827-CRM	Staphylococcus aureus subsp. aureus derived from ATCC® 6538P™*	2	
0485-CRM	Staphylococcus aureus subsp. aureus derived from ATCC® 6538™*	2	
0371-CRM	Staphylococcus epidermidis derived from ATCC® 12228™*	1	
0412-CRM	Staphylococcus epidermidis derived from ATCC® 14990™*	1	
0494-CRM	Staphylococcus saprophyticus derived from ATCC® 15305™*	1	
0947-CRM	Streptococcus pneumoniae derived from ATCC® 49619™*	2	Penicillin intermediate by altered penicillin-binding protein; Serotype 19F, type 19; CLSI and EUCAST QC strain for Disk Diffusion and MIC Determination
0385-CRM	Streptococcus pyogenes derived from ATCC® 19615™*	2	Group A
0818-CRM	Vibrio parahaemolyticus derived from ATCC® 17802™*	2	
0316-CRM	Yersinia enterocolitica subsp. enterocolitica derived from ATCC® 23715™*	2	



*Look for the ATCC Licensed Derivative® Emblem for all products derived from ATCC® cultures. The ATCC Licensed Derivative Emblem, the ATCC Licenses Derivative Word Mark, and the ATCC Catalog Marks are trademarks of ATCC. Microbiology, Inc. is licensed to use these trademarks and to sell products derived from ATCC® cultures.



Quantitative QC Microorganisms Classified as Certified Reference Material for ISO 17025 Accredited Laboratories



Highlights:

- Quantitative QC microorganisms one passage from the reference strains for ultimate authenticity
- For testing laboratories, Section 6.5.2 of ISO 17025:2017 states: "The laboratory shall ensure that measurement results are traceable to the International System of Units (SI) through: b) certified values of certified reference materials provided by a competent producer with stated metrological traceability to the SI..."
- Available in concentrations ranging from 10^2 to 10^8 CFU per pellet
- Can be combined for a mixed microorganism population
- Easily manipulated to deliver desired CFU concentrations
- Ready-to-use format saves time and money
- Refrigerated storage is easy and economical
- Online Certificate of Analysis provides detailed strain information
- Traceability to reference cultures ensures authenticity
- Technical Support experts available for guidance

Applications:

- Verification and Validation
- Enumeration methods
- ISO 17025 laboratories requiring CRM

Package Details:

- Vial of ten quantitated lyophilized microorganism pellets
- Certificate of Analysis
- Instructions for Use



1

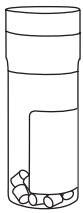

Remove the vial of pellets from refrigerated storage and allow to equilibrate to room temperature.

2

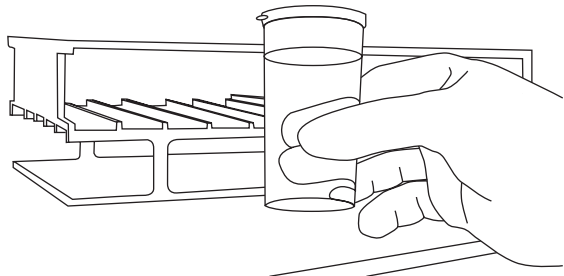

Prior to use, warm hydrating and dilution fluids to 34°C–38°C. Sterile pH 7.2 phosphate buffer is recommended for hydration of the lyophilized preparation.

3

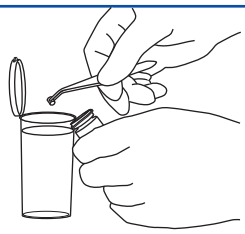

With sterile forceps, transfer the Epower™ CRM microorganism pellet(s) to the hydrating fluid. Do not remove the desiccant from vial. Immediately stopper and recap the vial and return to 2°C–8°C.

4

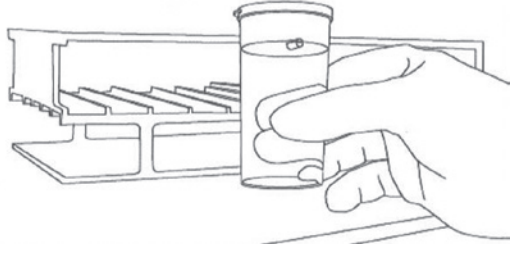

Place the microorganism suspension into a 34°C–38°C incubator for 30 minutes to assure complete hydration.

5



Immediately following incubation, mix hydrated material until a homogeneous suspension is achieved.

6

Proceed with the challenge according to laboratory protocol. The challenge must be completed within 30 minutes of the hydration process to avoid a change in the challenge suspension concentration.

Not intended for clinical use

Epower CRM

Catalog Number	Product Description	BSL	Comment
0392E3-CRM	Aspergillus brasiliensis derived from ATCC® 16404™*	1	Mold; Quantitative preparations at a concentration of 1.0-9.9E+03 CFU per pellet
0392E6-CRM	Aspergillus brasiliensis derived from ATCC® 16404™*	1	Mold; Quantitative preparations at a concentration of 1.0-9.9E+06 CFU per pellet
0998E3-CRM	Bacillus cereus derived from ATCC® 10876™*	1	Quantitative preparations at a concentration of 1.0-9.9E+03 CFU per pellet
0486E3-CRM	Bacillus subtilis subsp. spizizenii derived from ATCC® 6633™*	1	Quantitative preparations at a concentration of 1.0-9.9E+03 CFU per pellet
0486E4-CRM	Bacillus subtilis subsp. spizizenii derived from ATCC® 6633™*	1	Quantitative preparations at a concentration of 1.0-9.9E+04 CFU per pellet
0486E6-CRM	Bacillus subtilis subsp. spizizenii derived from ATCC® 6633™*	1	Quantitative preparations at a concentration of 1.0-9.9E+06 CFU per pellet
0443E3-CRM	Candida albicans derived from ATCC® 10231™*	1	Yeast cells; Quantitative preparations at a concentration of 1.0-9.9E+03 CFU per pellet
0443E7-CRM	Candida albicans derived from ATCC® 10231™*	1	Yeast cells; Quantitative preparations at a concentration of 1.0-9.9E+07 CFU per pellet
0487E3-CRM	Clostridium sporogenes derived from ATCC® 11437™*	1	Quantitative preparations at a concentration of 1.0-9.9E+03 CFU per pellet
0366E3-CRM	Enterococcus faecalis derived from ATCC® 29212™*	2	Quantitative preparation at a concentration of 1.0-9.9E+03 CFU per pellet
0495E3-CRM	Escherichia coli derived from ATCC® 35218™*	1	Quantitative preparations at a concentration of 1.0-9.9E+03 CFU per pellet
0791E3-CRM	Escherichia coli derived from ATCC® 51813™*	1	Quantitative preparations at a concentration of 1.0-9.9E+03 CFU per pellet
0791E4-CRM	Escherichia coli derived from ATCC® 51813™*	1	Quantitative preparations at a concentration of 1.0-9.9E+04 CFU per pellet
0306E3-CRM	Klebsiella aerogenes derived from ATCC® 13048™*	1	Quantitative preparations at a concentration of 1.0-9.9E+03 CFU per pellet; formerly Enterobacter aerogenes
0684E7-CRM	Klebsiella pneumoniae subsp. pneumoniae derived from ATCC® 10031™*	2	Quantitative preparations at a concentration of 1.0-9.9E+07 CFU per pellet; Methyl Red positive, Voges-Proskauer negative
0688E3-CRM	Kocuria rhizophila derived from ATCC® 9341™*	1	Quantitative preparations at a concentration of 1.0-9.9E+03 CFU per pellet
0688E4-CRM	Kocuria rhizophila derived from ATCC® 9341™*	1	Quantitative preparations at a concentration of 1.0-9.9E+04 CFU per pellet
0813E3-CRM	Lactobacillus fermentum derived from ATCC® 9338™*	1	Quantitative preparations at a concentration of 1.0-9.9E+03 CFU per pellet
0814E2-CRM	Listeria innocua derived from ATCC® 33090™*	1	Serotype 6a; Quantitative preparations at a concentration of 1.0-9.9E+02 CFU per pellet
0129E3-CRM	Listeria monocytogenes derived from ATCC® 13932™*	2	Serotype 4b; Quantitative preparations at a concentration of 1.0-9.9E+03 CFU per pellet
0277E3-CRM	Listeria monocytogenes derived from ATCC® 19111™*	2	Serotype 1; Quantitative preparations at a concentration of 1.0-9.9E+03 CFU per pellet
0687E3-CRM	Listeria monocytogenes derived from ATCC® 19115™*	2	Quantitative preparations at a concentration of 1.0-9.9E+03 CFU per pellet; serotype 4b
0794E3-CRM	Penicillium venetum derived from ATCC® 16025™*	1	Quantitative preparations at a concentration of 1.0-9.9E+03 CFU per pellet; Mold
0698E3-CRM	Saccharomyces kudriavzevii derived from ATCC® 2601™*	1	Quantitative preparations at a concentration of 1.0-9.9E+03 CFU per pellet; Formerly Saccharomyces cerevisiae; Yeast cells



*Look for the ATCC Licensed Derivative® Emblem for all products derived from ATCC® cultures. The ATCC Licensed Derivative Emblem, the ATCC Licenses Derivative Word Mark, and the ATCC Catalog Marks are trademarks of ATCC. Microbiology, Inc. is licensed to use these trademarks and to sell products derived from ATCC® cultures.

Epower CRM

Catalog Number	Product Description	BSL	Comment
0421E3-CRM	Salmonella enterica subsp. enterica serovar Typhimurium derived from ATCC® 13311™*	2	Quantitative preparations at a concentration of 1.0-9.9E+03 CFU per pellet
0363E3-CRM	Salmonella enterica subsp. enterica serovar Typhimurium derived from ATCC® 14028™*	2	Quantitative preparation at a concentration of 1.0-9.9E+03 CFU per pellet
0363E4-CRM	Salmonella enterica subsp. enterica serovar Typhimurium derived from ATCC® 14028™*	2	Quantitative preparation at a concentration of 1.0-9.9E+04 CFU per pellet
0360E3-CRM	Staphylococcus aureus subsp. aureus derived from ATCC® 25923™*	2	Quantitative preparations at a concentration of 1.0-9.9E+03 CFU per pellet; CAMP Test control
0360E4-CRM	Staphylococcus aureus subsp. aureus derived from ATCC® 25923™*	2	Quantitative preparations at a concentration of 1.0-9.9E+04 CFU per pellet; Camp Test control
0485E7-CRM	Staphylococcus aureus subsp. aureus derived from ATCC® 6538™*	2	Quantitative preparations at a concentration of 1.0-9.9E+07 CFU per pellet
0485E3-CRM	Staphylococcus aureus subsp. aureus derived from ATCC® 6538™*	2	Quantitative preparations at a concentration of 1.0-9.9E+03 CFU per pellet
0158E4-CRM	Staphylococcus aureus subsp. aureus derived from ATCC® 700699™*	2	Methicillin resistant; Quantitative preparations at a concentration of 1.0-9.9E+04 CFU per pellet
0371E3-CRM	Staphylococcus epidermidis derived from ATCC® 12228™*	1	Quantitative preparations at a concentration of 1.0-9.9E+03 CFU per pellet



*Look for the ATCC Licensed Derivative® Emblem for all products derived from ATCC® cultures. The ATCC Licensed Derivative Emblem, the ATCC Licenses Derivative Word Mark, and the ATCC Catalog Marks are trademarks of ATCC. Microbiologics, Inc. is licensed to use these trademarks and to sell products derived from ATCC® cultures.

UV·BioTAG™

Qualitative Ready-to-Use
QC Microorganisms with
Green Fluorescent Protein Tags



Highlights:

- Fluoresces under UV light to distinguish QC strains from other possible contaminants
- Instant dissolve pellet reduces preparation time
- Refrigerated storage is easy and economical
- Online Certificate of Analysis provides detailed strain information
- Traceability to reference cultures ensures authenticity
- Technical Support experts available for guidance

Applications:

- Enumeration methods
- Detection methods
- Demonstration of Capability (DOC)
- Media QC
- Verification and Validation

Package Details:

- **Swab Kits:** six all-in-one devices including a lyophilized microorganism pellet, ampoule of hydration fluid and inoculating swab
- **Vial Kits:** six lyophilized microorganism pellets in individual glass vials
- Instructions for Use

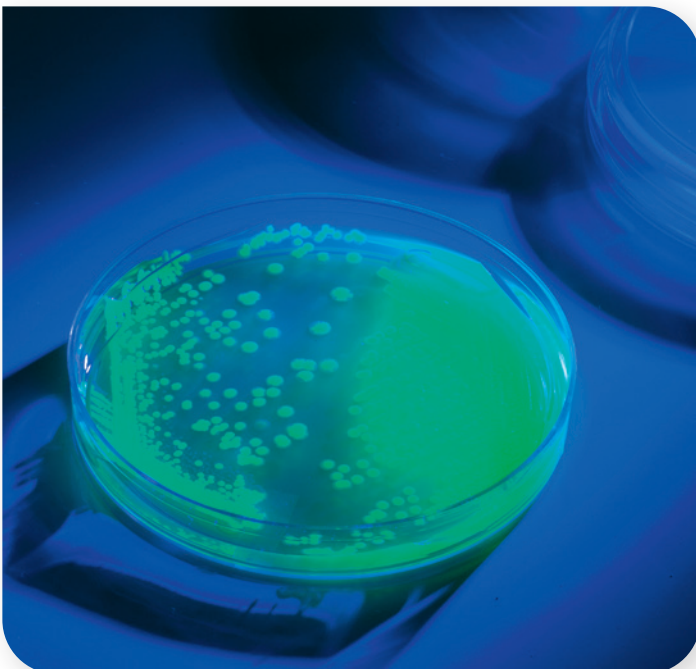

1

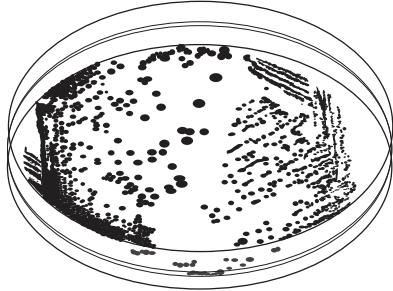

Following completion of the incubation period or test method, colonies growing on agar may be examined for fluorescence to determine whether the growth originated from the control strain or from contaminants.

2

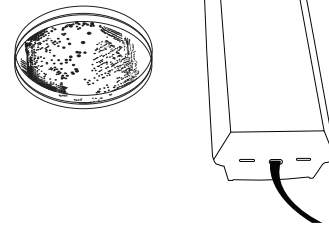

A long wave UV lamp and a dark room are needed for the detection of fluorescence. UV-BioTAG microorganisms' fluorescence is best detected using a UV lamp that emits the following wavelengths:

- a. 315 nm to 400 nm (for use with Escherichia, Salmonella and Shigella strains)
- b. 475 – 495 nm (for use with Listeria monocytogenes strains; use simultaneously with blue light barrier glasses)

3

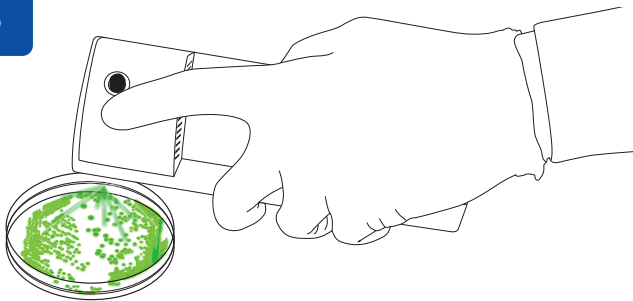

Hold the lamp over the microorganism culture being tested for fluorescence. Visually examine the culture and determine whether or not it fluoresces. The expected result when the culture is being grown on Tryptic Soy Agar is a green fluorescence. Other agars and variables within each laboratory's processes may produce fluorescence with varying colors, or may mask the expression of the GFP due to biochemical byproducts produced during the test.

4

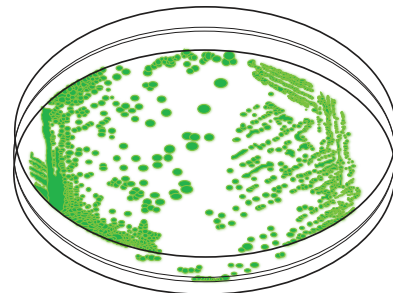

Green fluorescent proteins will continue to be expressed upon subculturing, but it is recommended that a new pellet suspension be used for each test. If the resuscitated culture is frozen, Microbiologics cannot guarantee the stated characteristics of the product.

Not intended for clinical use

UV-BioTAG

Catalog Number	Product Description	BSL	Comment
UV-BioTAG Swab Kits			
01227UV-S	Escherichia coli (O157:H7) EC43 derived from FDA ESC1177 (STEC)	2	GFP _{UV} Serotype O157:H7 Resistant to 10µg/ml Chloramphenicol Export license required for shipping outside the U.S.
01271UV-S	Listeria innocua (6a) modified from NCTC 11288	1	GFP _{UV} Serotype 6a Erythromycin resistant
01249UV-S	Listeria monocytogenes (1/2a) derived from FDA LS808	2	GFP _{UV} Serotype 1/2a Erythromycin resistant
01248UV-S	Listeria monocytogenes (1/2b) derived from FDA LS810	2	GFP _{UV} Serotype 1/2b Erythromycin resistant Rifampicin resistant
01250UV-S	Listeria monocytogenes (4b) derived from FDA LS806	2	GFP _{UV} Serotype 4b Erythromycin resistant Streptomycin resistant
01226UV-S	Salmonella enterica subsp. enterica serovar Senftenberg Sal59 derived from FDA SAL5697	2	GFP _{UV} Lactose- H ₂ S- Resistant to 10µg/ml Chloramphenicol
01223UV-S	Salmonella enterica subsp. enterica serovar Typhimurium Sal54 derived from FDA SAL5694	2	GFP _{UV} H ₂ S+ Resistant to 10µg/ml Chloramphenicol
01224UV-S	Shigella flexneri SF84 derived from FDA SHI0552	2	GFP _{UV} Resistant to 25µg/ml Kanamycin Resistant to 10µg/ml Chloramphenicol
UV-BioTAG Vial Kits			
01227UV-V	Escherichia coli (O157:H7) EC43 derived from FDA ESC1177 (STEC)	2	GFP _{UV} Serotype O157:H7 Resistant to 10µg/ml Chloramphenicol Export license required for shipping outside the U.S.
01271UV-V	Listeria innocua (6a) modified from NCTC 11288	1	GFP _{UV} Serotype 6a Erythromycin resistant
01249UV-V	Listeria monocytogenes (1/2a) derived from FDA LS808	2	GFP _{UV} Serotype 1/2a Erythromycin resistant
01248UV-V	Listeria monocytogenes (1/2b) derived from FDA LS810	2	GFP _{UV} Serotype 1/2b Erythromycin resistant Rifampicin resistant
01250UV-V	Listeria monocytogenes (4b) derived from FDA LS806	2	GFP _{UV} Serotype 4b Erythromycin resistant Streptomycin resistant
01226UV-V	Salmonella enterica subsp. enterica serovar Senftenberg Sal59 derived from FDA SAL5697	2	GFP _{UV} Lactose- H ₂ S- Resistant to 10µg/ml Chloramphenicol
01223UV-V	Salmonella enterica subsp. enterica serovar Typhimurium Sal54 derived from FDA SAL5694	2	GFP _{UV} H ₂ S+ Resistant to 10µg/ml Chloramphenicol
01224UV-V	Shigella flexneri SF84 derived from FDA SHI0552	2	GFP _{UV} Resistant to 25µg/ml Kanamycin Resistant to 10µg/ml Chloramphenicol

EZ·SPORE™

Quantitative QC Microorganisms for Validation and Verification of Spoilage Detection Methods



Highlights:

- EZ-SPORE™ contains 10⁴ CFU per pellet
- Ready-to-use format saves time and money
- Refrigerated storage is easy and economical
- Online Certificate of Analysis provides detailed strain information
- Traceability to reference cultures ensures authenticity
- Technical Support experts available for guidance
- Strains are three passages or fewer from the reference culture

Applications:

- Daily Food Process Controls
- Spoilage Detection Methods
- Disinfectant Qualification Studies

Package Details:

- Vial of ten lyophilized pellets
- Instructions for Use



EZ-SPORE™ ILLUSTRATED INSTRUCTIONS

1

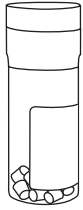

Remove the vial of pellets from refrigerated storage. Allow the unopened vial to equilibrate to room temperature (about 30 minutes).

2



Prior to use, warm hydrating and dilution fluids to 34°C-38°C. Sterile pH 7.2 phosphate buffer is recommended for hydration of the lyophilized preparation.

3

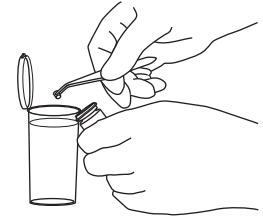

With sterile forceps, transfer the EZ-SPORE™ microorganism pellet to the hydrating fluid. Do not remove the desiccant from vial. Immediately stopper and recap vial and return to 2°C-8°C.

4

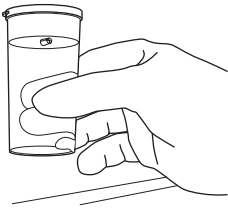

Place the microorganism suspension into a 34°C-38°C incubator for 30 minutes to ensure complete hydration.

5



Immediately following incubation, mix hydrated material until a homogeneous suspension is achieved.

9

Proceed with the challenge according to laboratory protocol.

10

The challenge must be completed within 30 minutes of the hydration process to avoid a change in the challenge suspension concentration.

Not intended for clinical use

EZ-SPORE

Catalog Number	Product Description	BSL
0256SPR	Bacillus cereus derived from ATCC® 11778™*	1
0486SPR	Bacillus subtilis subsp. spizizenii derived from ATCC® 6633™*	1
0871SPR	Geobacillus stearothermophilus derived from ATCC® 7953™*	1



*Look for the ATCC Licensed Derivative® Emblem for all products derived from ATCC® cultures. The ATCC Licensed Derivative Emblem, the ATCC Licensed Derivative Word Mark, and the ATCC Catalog Marks are trademarks of ATCC. Microbiologics, Inc. is licensed to use these trademarks and to sell products derived from ATCC® cultures.



Extremely Versatile, Ready-to-Use Quantitative QC Microorganisms for Enumeration Methods



Highlights:

- Available in concentrations ranging from 10^2 to 10^8 CFU per pellet
- May be combined for a mixed microorganism population
- Easily manipulated to deliver a wide variety of concentrations
- Ready-to-use format saves time and money
- Refrigerated storage is easy and economical
- Online Certificate of Analysis provides detailed strain information
- Traceability to reference cultures ensures authenticity
- Technical Support experts available for guidance
- Strains are three passages or fewer from the reference culture

Applications:

- Detection and enumeration methods
- Verification and Validation
- Bioburden determination
- Minimal lethal concentration
- Disinfectant qualification
- Water tests
- Proficiency tests
- Methods requiring a specific CFU range

Package Details:

- Vial of ten quantitated lyophilized pellets
- Instructions for Use



1

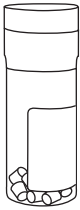

Remove the vial of pellets from refrigerated storage and allow to equilibrate to room temperature.

2

Prior to use, warm hydrating and dilution fluids to 34°C - 38°C. Sterile pH 7.2 phosphate buffer is recommended for hydration of the lyophilized preparation.

3



With sterile forceps, transfer the Epower™ microorganism pellet(s) to the hydrating fluid. Do not remove the desiccant from vial. Immediately stopper and recap the vial and return to 2°C - 8°C.

4

Place the microorganism suspension into a 34°C - 38°C incubator for 30 minutes to assure complete hydration.

5

Immediately following incubation, mix hydrated material until a homogeneous suspension is achieved.



6

Proceed with the challenge according to laboratory protocol. The challenge must be completed with 30 minutes of the hydration process to avoid a change in the challenge suspension concentration.

Not intended for clinical use

Catalog Number	Product Description	BSL	Comment
0392E3	Aspergillus brasiliensis derived from ATCC® 16404™*	1	Quantitative preparations at a concentration of 1.0-9.9E+03 CFU per pellet; mold
0392E6	Aspergillus brasiliensis derived from ATCC® 16404™*	1	Quantitative preparations at a concentration of 1.0-9.9E+06 CFU per pellet; mold
0998E3	Bacillus cereus derived from ATCC® 10876™*	1	Quantitative preparations at a concentration of 1.0-9.9E+03 CFU per pellet
0486E3	Bacillus subtilis subsp. spizizenii derived from ATCC® 6633™*	1	Quantitative preparations at a concentration of 1.0-9.9E+03 CFU per pellet
0486E4	Bacillus subtilis subsp. spizizenii derived from ATCC® 6633™*	1	Quantitative preparations at a concentration of 1.0-9.9E+04 CFU per pellet
0486E6	Bacillus subtilis subsp. spizizenii derived from ATCC® 6633™*	1	Quantitative preparations at a concentration of 1.0-9.9E+06 CFU per pellet
0488E7	Burkholderia cepacia derived from ATCC® 25416™*	2	Quantitative preparations at a concentration of 1.0-9.9E+07 CFU per pellet
0836E7	Burkholderia cepacia derived from ATCC® 25608™*	2	Quantitative preparations at a concentration of 1.0-9.9E+07 CFU per pellet
0443E3	Candida albicans derived from ATCC® 10231™*	1	Quantitative preparations at a concentration of 1.0-9.9E+03 CFU per pellet; yeast cells
0443E4	Candida albicans derived from ATCC® 10231™*	1	Quantitative preparations at a concentration of 1.0-9.9E+04 CFU per pellet; yeast cells
0443E7	Candida albicans derived from ATCC® 10231™*	1	Quantitative preparations at a concentration of 1.0-9.9E+07 CFU per pellet; yeast cells
0674E3	Clostridium perfringens derived from ATCC® 12919™*	2	Quantitative preparations at a concentration 1.0-9.9E+03 CFU per pellet; export license required for shipping outside U.S.
0487E3	Clostridium sporogenes derived from ATCC® 11437™*	1	Quantitative preparations at a concentration of 1.0-9.9E+03 CFU per pellet
0317E3	Clostridium sporogenes derived from ATCC® 19404™*	1	Quantitative preparations at a concentration of 1.0-9.9E+03 CFU per pellet
0756E3	Cronobacter muytjensii derived from ATCC® 51329™*	1	Quantitative preparations at a concentration of 1.0-9.9E+03 CFU per pellet
0388E8	Enterobacter cloacae subsp. cloacae derived from ATCC® 35030™*	1	Quantitative preparations at a concentration of 1.0-9.9E+08 CFU per pellet
0366E3	Enterococcus faecalis derived from ATCC® 29212™*	2	Quantitative Preparation at a concentration of 1.0-9.9E+03 CFU per pellet
0366E7	Enterococcus faecalis derived from ATCC® 29212™*	2	Quantitative Preparation at a concentration of 1.0-9.9E+07 CFU per pellet
0497E3	Enterococcus faecalis derived from ATCC® 7080™*	2	Quantitative Preparation at a concentration of 1.0-9.9E+03 CFU per pellet
01101E3	Escherichia coli (O103:H11) derived from CDC 06-3008	2	Quantitative preparations at a concentration 1.0-9.9E+03 CFU per pellet; serotype O103:H11; eae positive; stx 1 and/or stx 2 positive; export license required for shipping outside U.S.
01104E3	Escherichia coli (O104:H4) derived from ATCC® BAA-2326™*	2	Quantitative preparations at a concentration 1.0-9.9E+03 CFU per pellet; serotype O104:H4; aggR positive; stx 2 positive; export license required for shipping outside U.S.
01102E3	Escherichia coli (O111:H8) derived from CDC 2010C-3114	2	Quantitative preparations at a concentration 1.0-9.9E+03 CFU per pellet; serotype O111:H8; eae positive; stx 1 and/or stx 2 positive; export license required for shipping outside U.S.



*Look for the ATCC Licensed Derivative® Emblem for all products derived from ATCC® cultures. The ATCC Licensed Derivative Emblem, the ATCC Licenses Derivative Word Mark, and the ATCC Catalog Marks are trademarks of ATCC. Microbiology, Inc. is licensed to use these trademarks and to sell products derived from ATCC® cultures.

Catalog Number	Product Description	BSL	Comment
01097E3	Escherichia coli (O145:NM) derived from CDC 99-3311	2	Quantitative preparations at a concentration 1.0-9.9E+03 CFU per pellet serotype O145:NM; eae positive; stx1 and/or stx 2 positive; export license required for shipping outside U.S.
0617E3	Escherichia coli (O157:H7) derived from ATCC® 35150™*	2	Quantitative preparations at a concentration of 1.0-9.9E+03 CFU per pellet; serotype O157:H7; export license required for shipping outside U.S.
0795E2	Escherichia coli (O157:H7) derived from ATCC® 43888™*	2	Quantitative preparations at a concentration of 1.0-9.9E+02 CFU per pellet; serotype O157:H7; does not produce Shiga-Like Toxin I or II
01100E2	Escherichia coli (O26:H11) derived from CDC 03-3014	2	Quantitative preparations at a concentration of 1.0-9.9E+02 CFU per pellet; serotype O26:H11; eae positive; stx 1 and/or stx 2 positive; export license required for shipping outside U.S.
01100E3	Escherichia coli (O26:H11) derived from CDC 03-3014	2	Quantitative preparations at a concentration of 1.0-9.9E+03 CFU per pellet; serotype O26:H11; eae positive; stx 1 and/or stx 2 positive; export license required for shipping outside U.S.
01098E3	Escherichia coli (O45:H2) derived from CDC 00-3039	2	Quantitative preparations at a concentration of 1.0-9.9E+03 CFU per pellet; serotype O45:H2; eae positive; stx 1 and/or stx 2 positive; export license required for shipping outside U.S.
0495E3	Escherichia coli derived from ATCC® 35218™*	1	Quantitative preparations at a concentration of 1.0-9.9E+03 CFU per pellet
0791E3	Escherichia coli derived from ATCC® 51813™*	1	Quantitative preparations at a concentration of 1.0-9.9E+03 CFU per pellet
0791E4	Escherichia coli derived from ATCC® 51813™*	1	Quantitative preparations at a concentration of 1.0-9.9E+04 CFU per pellet
0483E3	Escherichia coli derived from ATCC® 8739™*	1	Quantitative preparations at a concentration of 1.0-9.9E+03 CFU per pellet
0483E7	Escherichia coli derived from ATCC® 8739™*	1	Quantitative preparations at a concentration of 1.0-9.9E+07 CFU per pellet
01192E3	Escherichia coli derived from NCTC 13216	2	Quantitative preparations at a concentration of 1.0-9.9E+03 CFU per pellet
0871E3	Geobacillus stearothermophilus derived from ATCC® 7953™*	1	Quantitative preparations at a concentration of 1.0-9.9E+03 CFU per pellet
0306E3	Klebsiella aerogenes derived from ATCC® 13048™*	1	Quantitative preparations at a concentration of 1.0-9.9E+03 CFU per pellet; formerly Enterobacter aerogenes
0684E7	Klebsiella pneumoniae subsp. pneumoniae derived from ATCC® 10031™*	2	Quantitative preparations at a concentration of 1.0-9.9E+07 CFU per pellet; Methyl Red positive, Voges-Proskauer negative
0688E3	Kocuria rhizophila derived from ATCC® 9341™*	1	Quantitative preparations at a concentration of 1.0-9.9E+03 CFU per pellet
0688E4	Kocuria rhizophila derived from ATCC® 9341™*	1	Quantitative preparations at a concentration of 1.0-9.9E+04 CFU per pellet
0813E3	Lactobacillus fermentum derived from ATCC® 9338™*	1	Quantitative preparations at a concentration of 1.0-9.9E+03 CFU per pellet
0149E3	Lactococcus lactis subsp. lactis derived from ATCC® 19435™*	1	Quantitative preparations at a concentration of 1.0-9.9E+03 CFU per pellet
0149E3	Lactococcus lactis subsp. lactis derived from ATCC® 19435™*	1	Quantitative preparations at a concentration of 1.0-9.9E+03 CFU per pellet



*Look for the ATCC Licensed Derivative® Emblem for all products derived from ATCC® cultures. The ATCC Licensed Derivative Emblem, the ATCC Licenses Derivative Word Mark, and the ATCC Catalog Marks are trademarks of ATCC. Microbiology, Inc. is licensed to use these trademarks and to sell products derived from ATCC® cultures.

Catalog Number	Product Description	BSL	Comment
0814E2	Listeria innocua (6a) derived from ATCC® 33090™*	1	Quantitative preparations at a concentration of 1.0-9.9E+02 CFU per pellet; serotype 6a
0414E3	Listeria innocua derived from NCTC 11288	1	Quantitative preparations at a concentration of 1.0-9.9E+03 CFU per pellet; serotype 6a
0129E3	Listeria monocytogenes derived from ATCC® 13932™*	2	Quantitative preparations at a concentration of 1.0-9.9E+03 CFU per pellet; serotype 4b
0277E3	Listeria monocytogenes derived from ATCC® 19111™*	2	Quantitative preparations at a concentration of 1.0-9.9E+03 CFU per pellet; serotype 1
0687E2	Listeria monocytogenes derived from ATCC® 19115™*	2	Quantitative preparations at a concentration of 1.0-9.9E+02 CFU per pellet; serotype 4b
0687E3	Listeria monocytogenes derived from ATCC® 19115™*	2	Quantitative preparations at a concentration of 1.0-9.9E+03 CFU per pellet; serotype 4b
0254E2	Listeria monocytogenes Cornell University derived from Silliker® SLR2249	2	Quantitative preparations at a concentration of 1.0-9.9E+02 CFU per pellet; Act A gene removed
0794E3	Penicillium venetum derived from ATCC® 16025™*	1	Quantitative preparations at a concentration of 1.0-9.9E+03 CFU per pellet; Mold
0693E3	Pseudomonas aeruginosa derived from ATCC® 15442™*	2	Quantitative preparations at a concentration of 1.0-9.9E+03 CFU per pellet; Pyocyanin not produced
0353E3	Pseudomonas aeruginosa derived from ATCC® 27853™*	2	Quantitative preparations at a concentration of 1.0-9.9E+03 CFU per pellet; Microbiologics does not recommend the use of this strain for testing Ceftriaxone using the disk diffusion method - we have found that this strain is displaying resistance to Ceftriaxone using this method
0353E6	Pseudomonas aeruginosa derived from ATCC® 27853™*	2	Quantitative preparations at a concentration of 1.0-9.9E+06 CFU per pellet; Microbiologics does not recommend the use of this strain for testing Ceftriaxone using the disk diffusion method - we have found that this strain is displaying resistance to Ceftriaxone using this method
0484E7	Pseudomonas aeruginosa derived from ATCC® 9027™*	2	Quantitative preparations at a concentration of 1.0-9.9E+07 CFU per pellet
0699E3	Saccharomyces cerevisiae derived from ATCC® 9763™*	1	Quantitative preparations at a concentration of 1.0-9.9E+03 CFU per pellet; yeast cells
0698E3	Saccharomyces kudriavzevii derived from ATCC® 2601™*	1	Quantitative preparations at a concentration of 1.0-9.9E+03 CFU per pellet; formerly Saccharomyces cerevisiae; yeast cells
0817E2	Salmonella enterica subsp. enterica serovar Abaetetuba derived from ATCC® 35640™*	2	Quantitative preparations at a concentration of 1.0-9.9E+02 CFU per pellet
0890E7	Salmonella enterica subsp. enterica serovar Abony derived from NCTC 6017	2	Quantitative preparations at a concentration of 1.0-9.9E+07 CFU per pellet; serovar Abony
0363E3	Salmonella enterica subsp. enterica serovar Typhimurium derived from ATCC® 14028™*	2	Quantitative preparation at a concentration of 1.0-9.9E+03 CFU per pellet
0363E4	Salmonella enterica subsp. enterica serovar Typhimurium derived from ATCC® 14028™*	2	Quantitative preparation at a concentration of 1.0-9.9E+04 CFU per pellet
0421E3	Salmonella enterica subsp. enterica serovar Typhimurium derived from ATCC® 13311™*	2	Quantitative preparations at a concentration of 1.0-9.9E+03 CFU per pellet
0421E7	Salmonella enterica subsp. enterica serovar Typhimurium derived from ATCC® 13311™*	2	Quantitative preparations at a concentration of 1.0-9.9E+07 CFU per pellet
0360E3	Staphylococcus aureus subsp. aureus derived from ATCC® 25923™*	2	Quantitative preparations at a concentration of 1.0-9.9E+03 CFU per pellet; CAMP Test control



*Look for the ATCC Licensed Derivative® Emblem for all products derived from ATCC® cultures. The ATCC Licensed Derivative Emblem, the ATCC Licenses Derivative Word Mark, and the ATCC Catalog Marks are trademarks of ATCC. Microbiologics, Inc. is licensed to use these trademarks and to sell products derived from ATCC® cultures.

Catalog Number	Product Description	BSL	Comment
0360E4	Staphylococcus aureus subsp. aureus derived from ATCC® 25923™*	2	Quantitative preparations at a concentration of 1.0-9.9E+04 CFU per pellet
0827E3	Staphylococcus aureus subsp. aureus derived from ATCC® 6538P™*	2	Quantitative preparations at a concentration of 1.0-9.9E+03 CFU per pellet
0485E3	Staphylococcus aureus subsp. aureus derived from ATCC® 6538™*	2	Quantitative preparations at a concentration of 1.0-9.9E+03 CFU per pellet
0485E7	Staphylococcus aureus subsp. aureus derived from ATCC® 6538™*	2	Quantitative preparations at a concentration of 1.0-9.9E+07 CFU per pellet
0158E4	Staphylococcus aureus subsp. aureus derived from ATCC® 700699™*	2	Quantitative preparations at a concentration of 1.0-9.9E+04 CFU per pellet; Methicillin resistant
0371E3	Staphylococcus epidermidis derived from ATCC® 12228™*	1	Quantitative preparations at a concentration of 1.0-9.9E+03 CFU per pellet
0371E4	Staphylococcus epidermidis derived from ATCC® 12228™*	1	Quantitative preparations at a concentration of 1.0-9.9E+04 CFU per pellet
0371E8	Staphylococcus epidermidis derived from ATCC® 12228™*	1	Quantitative preparations at a concentration of 1.0-9.9E+08 CFU per pellet
0803E3	Zygosaccharomyces rouxii derived from ATCC® 28253™*	1	Quantitative preparations at a concentration of 1.0-9.9E+03 CFU per pellet; yeast cells
0803E4	Zygosaccharomyces rouxii derived from ATCC® 28253™*	1	Quantitative preparations at a concentration of 1.0-9.9E+04 CFU per pellet; yeast cells



Qualitative QC Microorganisms Only Two Passages from Reference Culture for Special Applications



Highlights:

- Ideal for special applications requiring strains that are fewer passages from the reference culture
- Two passages from the reference culture, allowing for more subcultures
- FDA listed and CE Marked as an *In Vitro* Diagnostic (IVD) Medical Device
- Convenient test-ready format saves time and money
- Refrigerated storage is easy and economical
- Online Certificate of Analysis provides detailed strain information
- Traceability to reference cultures ensures authenticity
- Technical Support experts available for guidance

Applications:

- Antibiotic assays
- Instrument validations
- Validation of neutralization methods
- Suitability of sterility tests
- Disinfectant qualification

Package Details:

- All-in-one design includes a lyophilized microorganism pellet, ampoule of hydrating fluid and inoculating swab
- Pack of five KWIK-STIKs
- Instructions for Use



ILLUSTRATED INSTRUCTIONS

1

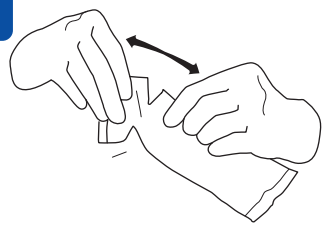

Allow the unopened KWIK-STIK™ pouch to equilibrate to room temperature. Tear open pouch at notch and remove the KWIK-STIK unit.

2

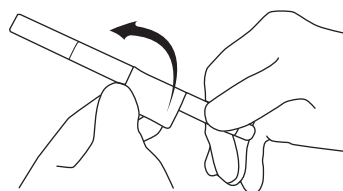

Tear off Pull-Tab portion on the label and attach it to primary culture plate or QC record. Do not disassemble the device during hydration.

3

Over the edge of the work bench or counter, crack the ampoule at the top of the KWIK-STIK (just below the fluid meniscus of the ampoule) found in the cap to release the hydrating fluid.

4

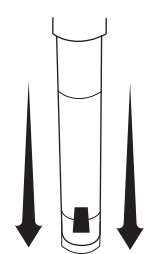

Hold vertically and tap on a hard surface to facilitate flow of fluid through shaft into bottom of unit containing pellet. Allow the hydrating fluid to flow through the swab shaft and into the bottom portion of the unit containing the pellet.

5

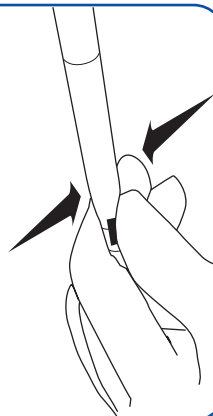

Using a pinching action on the bottom portion of the unit, crush the pellet in the fluid until the pellet suspension is homogenous.

6

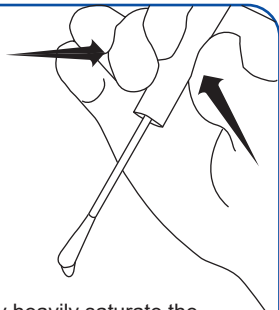

Immediately heavily saturate the swab with the hydrated material and transfer to agar medium, or use according to the laboratory's SOP.

7

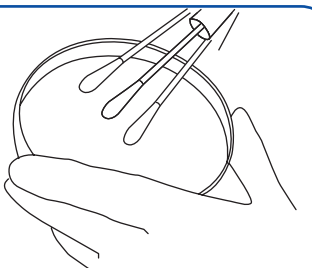

Inoculate the primary culture plate(s) by gently rolling the swab over one-third of the plate.

8

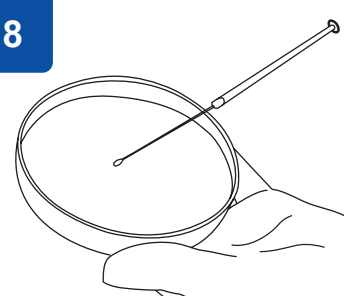

Using a sterile loop, streak to facilitate colony isolation.

9



Using proper biohazard disposal, discard the KWIK-STIK.

10

Immediately incubate the inoculated primary culture plate(s) at temperature and conditions appropriate to the microorganism.

Catalog Number	Product Description	BSL	Comment
0357X	Acinetobacter baumannii derived from ATCC® 19606™*	2	
0392X	Aspergillus brasiliensis derived from ATCC® 16404™*	1	
0500X	Aspergillus niger derived from ATCC® 6275™*		Mold
0998X	Bacillus cereus derived from ATCC® 10876™*	1	
0256X	Bacillus cereus derived from ATCC® 11778™*	1	
0198X	Bacillus cereus derived from ATCC® 33019™*	2	
0812X	Bacillus licheniformis derived from ATCC® 12759™*	1	
0258X	Bacillus pumilus derived from ATCC® 14884™*	1	
0486X	Bacillus subtilis subsp. spizizenii derived from ATCC® 6633™*	1	
0445X	Bacteroides vulgatus derived from ATCC® 8482™*	2	
0671X	Bordetella bronchiseptica derived from ATCC® 4617™*	2	
0139X	Brevibacillus agri derived from ATCC® 51663™*	1	
0805X	Brevundimonas diminuta derived from ATCC® 19146™*	1	
0488X	Burkholderia cepacia derived from ATCC® 25416™*	2	
0836X	Burkholderia cepacia derived from ATCC® 25608™*	2	
0443X	Candida albicans derived from ATCC® 10231™*	1	Yeast cells
0332X	Candida albicans derived from ATCC® 14053™*	1	Yeast cells
0487X	Clostridium sporogenes derived from ATCC® 11437™*	1	
0317X	Clostridium sporogenes derived from ATCC® 19404™*	1	
0323X	Enterobacter cloacae subsp. cloacae derived from ATCC® 13047™*	1	
0755X	Enterobacter hormaechei derived from ATCC® 700323™*	1	Formerly Enterobacter cloacae subsp. cloacae
0761X	Enterococcus casseliflavus derived from ATCC® 700327™*	1	
0366X	Enterococcus faecalis derived from ATCC® 29212™*	2	
0678X	Enterococcus hirae derived from ATCC® 10541™*	1	
0650X	Enterococcus hirae derived from ATCC® 8043™*	1	
0335X	Escherichia coli derived from ATCC® 25922™*	1	
0617X	Escherichia coli (O157:H7) derived from ATCC® 35150™* (STEC)	2	Export license required for shipping outside U.S.
0483X	Escherichia coli derived from ATCC® 8739™*	1	
0531X	Fusarium solani derived from ATCC® 36031™*	2	Mold
0871X	Geobacillus stearothermophilus derived from ATCC® 7953™*	1	
0647X	Haemophilus influenzae derived from ATCC® 49247™*	2	Reduced susceptibility to beta-lactam agents due to PBP mutations in Haemophilus influenzae; Ampicillin resistant; CLSI and EUCAST control for antimicrobial susceptibility testing
0919X	Haemophilus influenzae derived from ATCC® 49766™*	2	CLSI and EUCAST antimicrobial susceptibility control strain

Catalog Number	Product Description	BSL	Comment
0306X	Klebsiella aerogenes derived from ATCC® 13048™*	1	Formerly Enterobacter aerogenes
0757X	Klebsiella oxytoca derived from ATCC® 700324™*	2	
0684X	Klebsiella pneumoniae subsp. pneumoniae derived from ATCC® 10031™*	2	Methyl Red positive; Voges-Proskauer negative
0351X	Klebsiella pneumoniae subsp. pneumoniae derived from ATCC® 13883™*	2	Methyl Red positive; Voges-Proskauer negative; Not thermotolerant: Does not grow at 44.5°C
0683X	Klebsiella pneumoniae subsp. pneumoniae derived from ATCC® 4352™*	2	
0688X	Kocuria rhizophila derived from ATCC® 9341™*	1	
0813X	Lactobacillus fermentum derived from ATCC® 9338™*	1	
0235X	Lactobacillus leichmannii derived from ATCC® 7830™*	1	Formerly Lactobacillus delbrueckii subsp. lactis
0687X	Listeria monocytogenes derived from ATCC® 19115™*	2	Serotype 4b
01110X	Methylobacterium extorquens derived from ATCC® BAA-2500™*	1	
0689X	Micrococcus luteus derived from ATCC® 10240™*	1	
0242X	Micrococcus luteus derived from ATCC® 4698™*	1	
0648X	Neisseria gonorrhoeae derived from ATCC® 49226™*	2	Chromosomally mediated penicillin-resistant Neisseria gonorrhoeae; CLSI control for antimicrobial susceptibility testing
0703X	Pluralibacter gergoviae derived from ATCC® 33028™*	2	Formerly Enterobacter gergoviae
0419X	Propionibacterium acnes derived from ATCC® 11827™*	1	
0690X	Proteus mirabilis derived from ATCC® 25933™*	2	
0693X	Pseudomonas aeruginosa derived from ATCC® 15442™*	2	Pyocyanin not produced
0199X	Pseudomonas aeruginosa derived from ATCC® 19429™*	2	
0353X	Pseudomonas aeruginosa derived from ATCC® 27853™*	2	Microbiologics does not recommend the use of this strain for testing Ceftriaxone using the disk diffusion method - we have found that this strain is displaying resistance to Ceftriaxone using this method
0484X	Pseudomonas aeruginosa derived from ATCC® 9027™*	2	
0524X	Pseudomonas protegens (G) derived from ATCC® 17386™*	1	
0699X	Saccharomyces cerevisiae derived from ATCC® 9763™*	1	Yeast cells
0698X	Saccharomyces kudriavzevii derived from ATCC® 2601™*	1	Formerly Saccharomyces cerevisiae; yeast cells
0890X	Salmonella enterica subsp. enterica serovar Abony derived from NCTC 6017	2	Serovar Abony
0902X	Salmonella enterica subsp. enterica serovar Choleraesuis derived from ATCC® 10708™*	2	H2S negative
0421X	Salmonella enterica subsp. enterica serovar Typhimurium derived from ATCC® 13311™*	2	
0363X	Salmonella enterica subsp. enterica serovar Typhimurium derived from ATCC® 14028™*	2	
0247X	Serratia marcescens derived from ATCC® 13880™*	1	
0806X	Serratia marcescens derived from ATCC® 14756™*	1	

KWIK-STIK Plus

Catalog Number	Product Description	BSL	Comment
01209X	Shigella boydii (2) derived from ATCC® 8700™	2	Serotype 2
0173X	Staphylococcus aureus subsp. aureus derived from ATCC® 12600™*	2	
0360X	Staphylococcus aureus subsp. aureus derived from ATCC® 25923™*	2	mecA negative; recommended for CAMP Test
0906X	Staphylococcus aureus subsp. aureus derived from ATCC® 29737™*	2	
0852X	Staphylococcus aureus subsp. aureus derived from ATCC® 43300™*	2	mecA positive; SCCmec type II positive; Methicillin and oxacillin resistant; CLSI control for cefoxitin disk diffusion, oxacillin agar, and antimicrobial susceptibility testing
0827X	Staphylococcus aureus subsp. aureus derived from ATCC® 6538P™*	2	
0485X	Staphylococcus aureus subsp. aureus derived from ATCC® 6538™*	2	
0371X	Staphylococcus epidermidis derived from ATCC® 12228™*	1	
0134X	Staphylococcus saprophyticus derived from ATCC® BAA-750™*	1	
0369X	Stenotrophomonas maltophilia derived from ATCC® 13637™*	1	
0759X	Stenotrophomonas maltophilia derived from ATCC® 17666™*	1	
0370X	Streptococcus agalactiae derived from ATCC® 13813™*	2	Group B; inonhemolytic in absence of CAMP Factor
0101X	Streptococcus equi subsp. zooepidemicus derived from ATCC® 43079™*	2	
0969X	Streptococcus mutans derived from ATCC® 35668™*	1	
0947X	Streptococcus pneumoniae derived from ATCC® 49619™*	2	Penicillin intermediate by altered penicillin-binding protein; Serotype 19F, type 19; CLSI and EUCAST QC strain for Disk Diffusion and MIC Determination
0385X	Streptococcus pyogenes derived from ATCC® 19615™*	2	Group A
0255X	Zygosaccharomyces rouxii derived from NCYC 381	1	



*Look for the ATCC Licensed Derivative® Emblem for all products derived from ATCC® cultures. The ATCC Licensed Derivative Emblem, the ATCC Licenses Derivative Word Mark, and the ATCC Catalog Marks are trademarks of ATCC. Microbiology, Inc. is licensed to use these trademarks and to sell products derived from ATCC® cultures.

Fast, Convenient and Reliable
QC Microorganisms for
Growth Promotion Testing



Highlights:

- Delivers 10-100 CFU per 0.1 ml as required by USP/Ph. Eur./JP
- Instant dissolve pellet reduces preparation time
- No dilutions required for simplified test procedure
- Up to eight hours stability allows for ultimate flexibility
- Refrigerated storage is easy and economical
- Online Certificate of Analysis provides detailed strain information
- Authentic, traceable strains at three passages or fewer from the reference culture – meets USP/Ph. Eur./JP requirements
- Technical Support experts available for guidance

Applications:

- Growth Promotion Testing
- Media Challenge Testing
- Suitability of Counting Methods
- Suitability of Sterility Tests
- Suitability of Tests for Specified Microorganisms
- Microbial Limits Testing
- Microbial Enumeration Testing
- Validation of Neutralization Methods
- Methods requiring a low CFU concentration

Package Details:

- Five vials of a single, quantitated microorganism (one lyophilized pellet per vial)
- Five vials of hydrating fluid (1.2 ml in each vial)
- Up to 50 tests per kit
- Instructions for Use

1

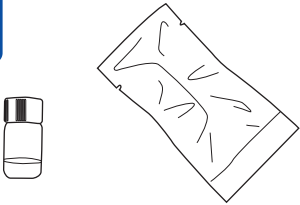

Remove 1 vial of hydrating fluid and 1 foil pouch containing lyophilized pellet from refrigerated storage. Allow unopened pouch and hydrating fluid to equilibrate to room temperature (about 30 minutes).

2

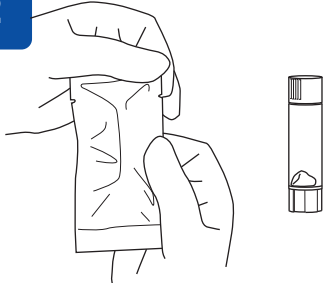

Tear open the foil pouch and remove the vial containing 1 lyophilized pellet.

3



Remove the cap from the pellet vial and the hydrating fluid vial. Tip 1 pellet into the 1.2 ml vial of hydrating fluid. Only 1 pellet must be used to obtain the challenge concentration of 10-100 CFU per 0.1 ml on non-selective media. Immediately recap hydrating fluid vial.

4



Vortex hydrated material until pellet has completely dissolved and suspension is homogeneous.

5

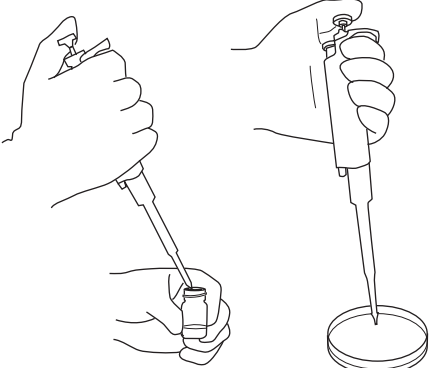

With a sterile pipette, transfer 0.1 ml of the hydrated suspension of the material being challenged (0.1 ml contains 10-100 CFU).

Note: Remaining suspension can be refrigerated and used for up to 8 hours, with the exception of catalog numbers 0353A and 0484A, which must be used within 30 minutes. Test suspension immediately after removing it from refrigerator.

6



Proceed with the challenge procedure according to laboratory protocol. Refrigerate suspension at 2°C - 8°C if it will be used again. Discard any remaining hydrated material in accordance with the laboratory protocol for disposal of biohazard materials.

Not intended for clinical use

EZ-Accu Shot

Catalog Number	Product Description	BSL	Comment
HF0532	1.2 ml Hydrating Fluid for EZ-Accu Shot, 10=1		Not for use with Pseudomonas
HF0533	1.2 ml Hydrating Fluid for Pseudomonas EZ-Accu Shot, 10=1		
0392A	Aspergillus brasiliensis derived from ATCC® 16404™*	1	
0998A	Bacillus cereus derived from ATCC® 10876™*	1	
0486A	Bacillus subtilis subsp. spizizenii derived from ATCC® 6633™*	1	
01092A	Bifidobacterium animalis subsp. animalis derived from ATCC® 25527™*	1	
0488A	Burkholderia cepacia derived from ATCC® 25416™*	2	
0443A	Candida albicans derived from ATCC® 10231™*	1	Yeast cells
0672A	Candida albicans derived from ATCC® 26790™*	1	Yeast cells
0487A	Clostridium sporogenes derived from ATCC® 11437™*	2	
0317A	Clostridium sporogenes derived from ATCC® 19404™*	2	
0419A	Cutibacterium acnes derived from ATCC® 11827™*	1	
0366A	Enterococcus faecalis derived from ATCC® 29212™*	2	
0650A	Enterococcus hirae derived from ATCC® 8043™*	1	
0483A	Escherichia coli derived from ATCC® 8739™*	1	
0680A	Escherichia coli derived from ATCC® 10536™*	1	
0681A	Escherichia coli derived from ATCC® 11229™*	1	
0872A	Geobacillus stearothermophilus derived from ATCC® 12980™*	1	Based on in-house studies, Microbiologics has found that G. stearothermophilus can produce significantly different results on different media brands
0871A	Geobacillus stearothermophilus derived from ATCC® 7953™*	1	Based on in-house studies, Microbiologics has found that G. stearothermophilus can produce significantly different results on different media brands
0306A	Klebsiella aerogenes derived from ATCC® 13048™*	1	Formerly Enterobacter aerogenes
0688A	Kocuria rhizophila derived from ATCC® 9341™*	1	
01090A	Lactobacillus rhamnosus derived from ATCC® 53103™*	1	
0242A	Micrococcus luteus derived from ATCC® 4698™*	1	
0440A	Proteus mirabilis derived from ATCC® 12453™*	2	
0353A	Pseudomonas aeruginosa derived from ATCC® 27853™*	2	Microbiologics does not recommend the use of this strain for testing Ceftriaxone using the disk diffusion method. We have found that this strain displays resistance to Ceftriaxone using this method.
0484A	Pseudomonas aeruginosa derived from ATCC® 9027™*	2	
0699A	Saccharomyces cerevisiae derived from ATCC® 9763™*	1	Yeast cells
0901A	Salmonella enterica subsp. arizonae derived from ATCC® 13314™*	2	
0890A	Salmonella enterica subsp. enterica serovar Abony derived from NCTC 6017	2	Serovar Abony

EZ-Accu Shot

Catalog Number	Product Description	BSL	Comment
0902A	Salmonella enterica subsp. enterica serovar Choleraesuis derived from ATCC® 10708™*	2	H2S negative
01087A	Salmonella enterica subsp. salamae serotype Tranaroa derived from NCTC 10252	2	Serotype Tranaroa
0421A	Salmonella enterica subsp. enterica serovar Typhimurium derived from ATCC® 13311™*	2	
0363A	Salmonella enterica subsp. enterica serovar Typhimurium derived from ATCC® 14028™*	2	
0356A	Shigella flexneri (2b) derived from ATCC® 12022™*	2	Serotype 2b; Group B
0360A	Staphylococcus aureus subsp. aureus derived from ATCC® 25923™*	2	
0827A	Staphylococcus aureus subsp. aureus derived from ATCC® 6538P™*	2	
0485A	Staphylococcus aureus subsp. aureus derived from ATCC® 6538™*	2	
0371A	Staphylococcus epidermidis derived from ATCC® 12228™*	1	



*Look for the ATCC Licensed Derivative® Emblem for all products derived from ATCC® cultures. The ATCC Licensed Derivative Emblem, the ATCC Licenses Derivative Word Mark, and the ATCC Catalog Marks are trademarks of ATCC. Microbiologics, Inc. is licensed to use these trademarks and to sell products derived from ATCC® cultures.



Five Compendial Strains Plus *E. coli* for Growth Promotion Testing in One Convenient Kit



Highlights:

- Delivers 10-100 CFU per 0.1 ml as required by USP/Ph. Eur./JP
- Kit includes the five USP compendial strains plus *E. coli* for Growth Promotion Testing
- Instant dissolve pellet reduces preparation time
- No dilutions required for simplified test procedure
- Up to eight hours stability allows for ultimate flexibility
- Ten tests for each microorganism per kit
- Refrigerated storage is easy and economical
- Online Certificate of Analysis provides detailed strain information
- Traceability to reference cultures ensures authenticity
- Technical Support experts available for guidance
- Strains are three passages or fewer from the reference culture

Applications:

- Growth Promotion Testing
- Media Challenge Testing
- Suitability of Counting Methods
- Suitability of Sterility Tests
- Suitability of Tests for Specified Microorganisms
- Microbial Limits Testing
- Microbial Enumeration Testing
- Validation of Neutralization Methods
- Methods requiring a low CFU concentration

Package Details:

- Six vials of six quantitated microorganism strains (one lyophilized pellet per vial)
- Six vials of hydrating fluid (1.2 ml in each vial)
- Up to 60 tests per kit
- Instructions for Use



1



Remove 1 vial of hydrating fluid and 1 foil pouch containing lyophilized pellet from refrigerated storage. Allow unopened pouch and hydrating fluid to equilibrate to room temperature (about 30 minutes).

2



Tear open the foil pouch and remove the vial containing 1 lyophilized pellet.

3

Remove the cap from the pellet vial and the hydrating fluid vial. Tip 1 pellet into the 1.2 ml vial of hydrating fluid. Only 1 pellet must be used to obtain the challenge concentration of 10–100 CFU per 0.1 ml on non-selective media. Immediately recap hydrating fluid vial.



4



Vortex hydrated material until pellet has completely dissolved and suspension is homogeneous.

5

With a sterile pipette, transfer 0.1 ml of the hydrated suspension to the material being challenged (0.1 ml contains 10–100 CFU).

Note: Remaining suspension can be refrigerated and used for up to 8 hours, with the exception of catalog number 0484A, which must be used within 30 minutes. Test suspension immediately after removing it from refrigerator.

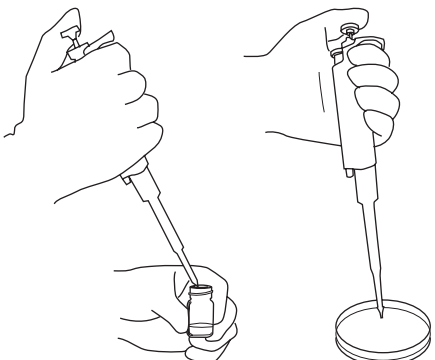

6



Proceed with the challenge procedure according to laboratory protocol. Refrigerate suspension at 2°C–8°C if it will be used again. Discard any remaining hydrated material in accordance with the laboratory protocol for disposal of biohazard materials.

Not intended for clinical use

EZ-Accu Shot Select

Catalog Number	Product Description	BSL
8172	0392A <i>Aspergillus brasiliensis</i> derived from ATCC® 16404™*	1
	0486A <i>Bacillus subtilis</i> subsp. <i>spizizenii</i> derived from ATCC® 6633™*	1
	0443A <i>Candida albicans</i> derived from ATCC® 10231™*	1
	0483A <i>Escherichia coli</i> derived from ATCC® 8739™*	1
	0484A <i>Pseudomonas aeruginosa</i> derived from ATCC® 9027™*	2
	0485A <i>Staphylococcus aureus</i> subsp. <i>aureus</i> derived from ATCC® 6538™*	2



*Look for the ATCC Licensed Derivative® Emblem for all products derived from ATCC® cultures. The ATCC Licensed Derivative Emblem, the ATCC Licenses Derivative Word Mark, and the ATCC Catalog Marks are trademarks of ATCC. Microbiologics, Inc. is licensed to use these trademarks and to sell products derived from ATCC® cultures.

EZ·CFU™ One Step

Ready-to-Use Quantitative
QC Microorganisms for
Growth Promotion Testing



Highlights:

- Delivers 10-100 CFU per 0.1 ml as required by USP/Ph. Eur./JP
- No dilutions required for simplified test procedure
- Up to eight hours stability allows for ultimate flexibility
- 19 testing events per set-up, 190 tests per kit
- Refrigerated storage is easy and economical
- Online Certificate of Analysis provides detailed strain information
- Traceability to reference cultures ensures authenticity
- Technical Support experts available for guidance
- Strains are three passages or fewer from the reference culture

Applications:

- Growth Promotion Testing
- Media Challenge Testing
- Suitability of Counting Methods
- Suitability of Sterility Tests
- Suitability of Tests for Specified Microorganisms
- Microbial Limits Testing
- Microbial Enumeration Testing
- Validation of Neutralization Methods
- Methods requiring a low CFU concentration

Package Details:

- 20 quantitated lyophilized microorganism pellets
- 10 vials of hydrating fluid (2 ml in each vial)
- Instructions for Use



EZ·CFU™ One Step ILLUSTRATED INSTRUCTIONS

1

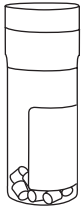

Remove the vial of lyophilized pellets from refrigerated storage (2°C–8°C). Allow the materials to equilibrate to room temperature (about 30 minutes) before opening the vial.

2

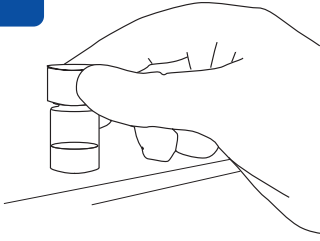

While the pellets are equilibrating, prewarm the hydrating fluid to 34°C–38°C (at least 30 minutes).

3

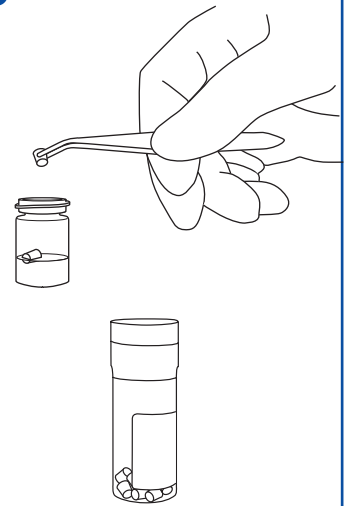

With a sterile forceps, transfer 2 pellets into the 2 ml vial of hydrating fluid. Do not remove the desiccant from vial. Two pellets must be used to obtain the challenge concentration of 10–100 CFU per 0.1 ml on non-selective media. Immediately stopper and recap the pellet vial and return the remaining lyophilized material to refrigerated storage 2°C–8°C.

4

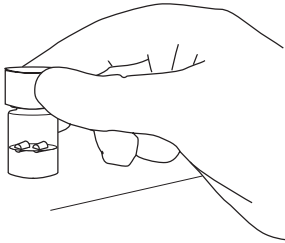

Immediately recap the vial with the hydrated material and place into a 34°C–38°C incubator for 30 minutes to ensure complete hydration.

5



Immediately following incubation, vortex the hydrated material until pellets have completely dissolved and suspension is homogeneous.

6

With a sterile pipette, transfer 0.1 ml of the hydrated suspension to the material being challenged (0.1 ml contains 10–100 CFU). Note: Remaining suspension can be refrigerated and used for up to 8 hours (no warming time required), with the exception of catalog number 0320Z which must be used within 30 minutes.

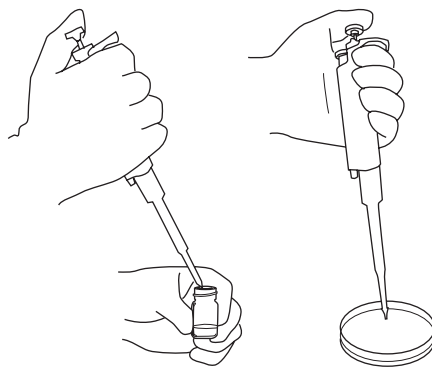

7



Proceed with the challenge procedure according to laboratory protocol. Discard any remaining hydrated material in accordance with the laboratory protocol for disposal of biohazard materials.

Not intended for clinical use

EZ-CFU One Step

Catalog Number	Product Description	BSL	Comment
0392Z	Aspergillus brasiliensis derived from ATCC® 16404™*	1	
0998Z	Bacillus cereus derived from ATCC® 10876™*	1	
0486Z	Bacillus subtilis subsp. spizizenii derived from ATCC® 6633™*	1	
0320Z	Bacteroides fragilis derived from ATCC® 25285™*	2	
0805Z	Brevundimonas diminuta derived from ATCC® 19146™*	1	
0488Z	Burkholderia cepacia derived from ATCC® 25416™*	2	
0443Z	Candida albicans derived from ATCC® 10231™*	1	Yeast cells
0896Z	Candida albicans derived from ATCC® 2091™*	1	Yeast cells
0487Z	Clostridium sporogenes derived from ATCC® 11437™*	1	
0317Z	Clostridium sporogenes derived from ATCC® 19404™*	1	
0366Z	Enterococcus faecalis derived from ATCC® 29212™*	2	
0483Z	Escherichia coli derived from ATCC® 8739™*	1	
0872Z	Geobacillus stearothermophilus derived from ATCC® 12980™*	1	Based on in-house studies, Microbiologics has found that G. stearothermophilus can produce significantly different results on different media brands
0871Z	Geobacillus stearothermophilus derived from ATCC® 7953™*	1	Based on in-house studies, Microbiologics has found that G. stearothermophilus can produce significantly different results on different media brands
0306Z	Klebsiella aerogenes derived from ATCC® 13048™*	1	Formerly Enterobacter aerogenes
0688Z	Kocuria rhizophila derived from ATCC® 9341™*	1	
0687Z	Listeria monocytogenes derived from ATCC® 19115™*	2	Serotype 4b
0242Z	Micrococcus luteus derived from ATCC® 4698™*	1	
0353Z	Pseudomonas aeruginosa derived from ATCC® 27853™*	2	Microbiologics does not recommend the use of this strain for testing Ceftriaxone using the disk diffusion method - we have found that this strain is displaying resistance to Ceftriaxone using this method
0484Z	Pseudomonas aeruginosa derived from ATCC® 9027™*	2	
0890Z	Salmonella enterica subsp. enterica serovar Abony derived from NCTC 6017	2	Serovar Abony
0363Z	Salmonella enterica subsp. enterica serovar Typhimurium derived from ATCC® 14028™*	2	
0360Z	Staphylococcus aureus subsp. aureus derived from ATCC® 25923™*	2	
0827Z	Staphylococcus aureus subsp. aureus derived from ATCC® 6538P™*	2	
0485Z	Staphylococcus aureus subsp. aureus derived from ATCC® 6538™*	2	
0371Z	Staphylococcus epidermidis derived from ATCC® 12228™*	1	
0385Z	Streptococcus pyogenes derived from ATCC® 19615™*	2	Group A

EZ·CFU™

Economical Quantitative QC Microorganisms for Growth Promotion Testing



Highlights:

- Delivers 10-100 CFU per 0.1 ml following a 1:10 dilution step
- 900+ tests per kit, ideal for high volume Growth Promotion Testing
- Refrigerated storage is easy and economical
- Online Certificate of Analysis provides detailed strain information
- Traceability to reference cultures ensures authenticity
- Technical Support experts available for guidance
- Strains are three passages or fewer from the reference culture

Applications:

- Growth Promotion Testing
- Media Challenge Testing
- Suitability of Counting Methods
- Suitability of Sterility Tests
- Suitability of Tests for Specified Microorganisms
- Microbial Limits Testing
- Microbial Enumeration Testing
- Validation of Neutralization Methods
- Methods requiring a low CFU concentration

Package Details:

- 20 quantitated lyophilized microorganism pellets
- 10 vials of hydrating fluid (2 ml in each vial)
- Instructions for Use

1

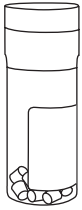

Remove the vial of lyophilized pellets from refrigerated storage. Allow unopened vial of lyophilized pellets to equilibrate to room temperature (about 30 minutes).

2

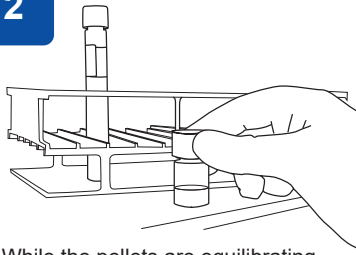

While the pellets are equilibrating, prewarm the hydrating fluid vial and a tube of 9.0 ml of phosphate buffer pH 7.2 to 34°C–38°C (at least 30 minutes).

3



With a sterile forceps, transfer 2 pellets to the 2 ml vial of hydrating fluid. Do not remove the desiccant from the vial. Two pellets must be used to obtain the challenge concentration of 10–100 CFU per 0.1 ml on non-selective media. Immediately recap the pellet vial and return the remaining lyophilized material to refrigerated storage 2°C–8°C.

4

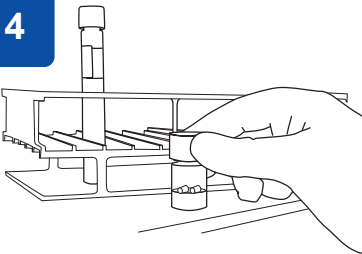

Immediately recap the vial with the hydrated material and place into a 34°C–38°C incubator for 30 minutes to ensure complete hydration.

5



Immediately following incubation, vortex the hydrated material until pellets have completely dissolved and suspension is homogeneous.

6

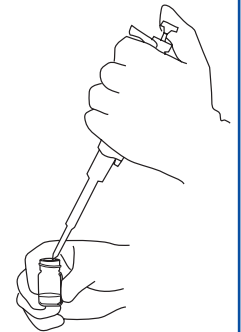

With a sterile pipette, transfer 1.0 ml of the hydrated suspension to the 9.0 ml tube of pH 7.2 phosphate buffer.

7

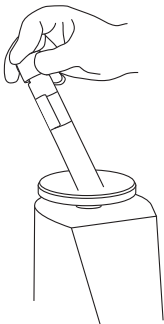

Vortex the working solution well.

8

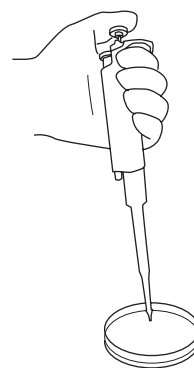

With a sterile pipette, transfer 0.1 ml from the working solution to the material being challenged (0.1 ml contains 10–100 CFU).

9



Proceed with the challenge procedure according to laboratory protocol. The challenge must be completed within 30 minutes of hydration. Discard any remaining hydrated material in accordance with the laboratory protocol for disposal of biohazard materials.

Not intended for clinical use

EZ-CFU

Catalog Number	Product Description	BSL	Comment
HF0509	2.0 ml Hydrating fluid for Pseudomonas		
HF0543	2.0 ml Hydrating Fluid		Not for use with Pseudomonas
0392C	Aspergillus brasiliensis derived from ATCC® 16404™*	1	
0998C	Bacillus cereus derived from ATCC® 10876™*	1	
0486C	Bacillus subtilis subsp. spizizenii derived from ATCC® 6633™*	1	
0445C	Bacteroides vulgatus derived from ATCC® 8482™*	2	
0443C	Candida albicans derived from ATCC® 10231™*	1	Yeast cells
0487C	Clostridium sporogenes derived from ATCC® 11437™*	1	
0317C	Clostridium sporogenes derived from ATCC® 19404™*	1	
0366C	Enterococcus faecalis derived from ATCC® 29212™*	2	
0483C	Escherichia coli derived from ATCC® 8739™*	1	
0872C	Geobacillus stearothermophilus derived from ATCC® 12980™*	1	Based on in-house studies, Microbiologics has found that G. stearothermophilus can produce significantly different results on different media brands
0871C	Geobacillus stearothermophilus derived from ATCC® 7953™*	1	Based on in-house studies, Microbiologics has found that G. stearothermophilus can produce significantly different results on different media brands
0306C	Klebsiella aerogenes derived from ATCC® 13048™*	1	Formerly Enterobacter aerogenes
0688C	Kocuria rhizophila derived from ATCC® 9341™*	1	
0813C	Lactobacillus fermentum derived from ATCC® 9338™*	1	
0687C	Listeria monocytogenes derived from ATCC® 19115™*	2	Serotype 4b
0353C	Pseudomonas aeruginosa derived from ATCC® 27853™*	2	Microbiologics does not recommend the use of this strain for testing Ceftriaxone using the disk diffusion method - we have found that this strain is displaying resistance to Ceftriaxone using this method
0484C	Pseudomonas aeruginosa derived from ATCC® 9027™*	2	
0524C	Pseudomonas protegens (G) derived from ATCC® 17386™*	1	Formerly Pseudomonas fluorescens; biotype G
0890C	Salmonella enterica subsp. enterica serovar Abony derived from NCTC 6017	2	Serovar Abony
0902C	Salmonella enterica subsp. enterica serovar Choleraesuis derived from ATCC® 10708™*	2	H2S negative
0421C	Salmonella enterica subsp. enterica serovar Typhimurium derived from ATCC® 13311™*	2	
0363C	Salmonella enterica subsp. enterica serovar Typhimurium derived from ATCC® 14028™*	2	
0360C	Staphylococcus aureus subsp. aureus derived from ATCC® 25923™*	2	
0827C	Staphylococcus aureus subsp. aureus derived from ATCC® 6538P™*	2	
0485C	Staphylococcus aureus subsp. aureus derived from ATCC® 6538™*	2	

EZ-CFU

Catalog Number	Product Description	BSL	Comment
0371C	Staphylococcus epidermidis derived from ATCC® 12228™*	1	
0385C	Streptococcus pyogenes derived from ATCC® 19615™*	2	Group A



*Look for the ATCC Licensed Derivative® Emblem for all products derived from ATCC® cultures. The ATCC Licensed Derivative Emblem, the ATCC Licenses Derivative Word Mark, and the ATCC Catalog Marks are trademarks of ATCC. Microbiologics, Inc. is licensed to use these trademarks and to sell products derived from ATCC® cultures.

EZ·PEC™

Ready-to-Use, Affordable Quantitative
QC Microorganisms for
Antimicrobial Effectiveness Testing



Highlights:

- Delivers 1.0×10^5 to 1.0×10^6 CFU per 1 ml of product tested
- Refrigerated storage is easy and economical
- Online Certificate of Analysis provides detailed strain information
- Traceability to reference cultures ensures authenticity
- Technical Support experts available for guidance
- Strains are three passages or fewer from the reference culture

Applications:

- Antimicrobial Effectiveness Testing
- Preservative Efficacy Testing
- Applications requiring a high CFU concentration

Package Details:

- 20 quantitated lyophilized microorganism pellets
- 10 vials of hydrating fluid (2 ml in each vial)
- Instructions for Use



1

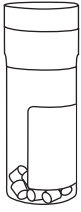

Remove the vial of lyophilized pellets from refrigerated storage (2°C–8°C). Allow the materials to equilibrate to room temperature (about 30 minutes) before opening the vial.

2

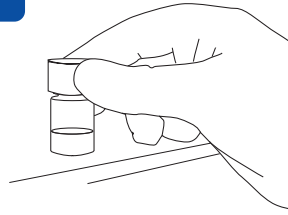

While the pellets are equilibrating, prewarm the hydrating fluid to 34°C–38°C (at least 30 minutes).

3

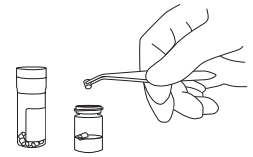

With a sterile forceps, transfer 2 pellets into the 2 ml vial of hydrating fluid. Do not remove the desiccant from vial. Immediately stopper and recap the pellet vial, and return the remaining lyophilized material to refrigerated storage 2°C–8°C.

4

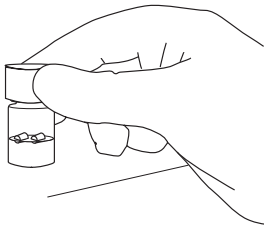

Immediately recap the vial with the hydrated material and place into a 34°C–38°C incubator for 30 minutes to ensure complete hydration.

5



Immediately following incubation, vortex the hydrated material until pellets have completely dissolved and suspension is homogeneous. Charcoal particles, which may be visible in the hydrated suspension, will not compromise challenge microorganism.

6

With a sterile pipette transfer a volume of hydrated suspension equal to 0.5% to 1.0% of the volume of the product being challenged. A 0.5% to 1.0% addition of microorganisms will automatically result in a concentration of 1.0E+05 to 1.0E+06 CFU per ml of product.

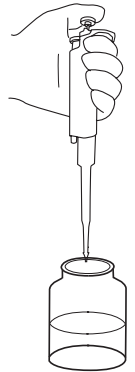

7



Proceed with the test according to laboratory protocol. The challenge must be completed within 30 minutes of hydration. Discard any remaining hydrated material in accordance with laboratory protocol for disposal of biohazard materials.

Not intended for clinical use

EZ-PEC

Catalog Number	Product Description	BSL	Comment
0392-PEC	Aspergillus brasiliensis derived from ATCC® 16404™*	1	
0486-PEC	Bacillus subtilis subsp. spizizenii derived from ATCC® 6633™*	1	
0443-PEC	Candida albicans derived from ATCC® 10231™*	1	Yeast cells
0483-PEC	Escherichia coli derived from ATCC® 8739™*	1	
0581-PEC	Escherichia coli derived from NCIMB 8545	2	
0484-PEC	Pseudomonas aeruginosa derived from ATCC® 9027™*	2	
0485-PEC	Staphylococcus aureus subsp. aureus derived from ATCC® 6538™*	2	
0360-PEC	Staphylococcus aureus subsp. aureus derived from ATCC® 25923™*	2	mecA negative



*Look for the ATCC Licensed Derivative® Emblem for all products derived from ATCC® cultures. The ATCC Licensed Derivative Emblem, the ATCC Licenses Derivative Word Mark, and the ATCC Catalog Marks are trademarks of ATCC. Microbiologics, Inc. is licensed to use these trademarks and to sell products derived from ATCC® cultures.



Microbial Controls Made From Your Environmental Isolates



Tracking and trending environmental microbial isolates is a growing concern for pharmaceutical, nutraceutical, medical device, personal care product and food manufacturing laboratories. Microbiologics offers a comprehensive program for environmental isolate management. Our team of experts will identify, characterize, preserve and manufacture your strain into a test-ready control format for ongoing QC.

Partner with Microbiologics to reduce cost, minimize risk and increase confidence in your environmental monitoring program.

Why Microbiologics?

- Over 45 years of experience developing and producing microbial controls
- Extensive range of simple and reliable qualitative and quantitative formats
- Independent external controls provide accurate, reliable results
- Convenient test-ready formats save you time and money
- Easy and economical storage, no freezing required
- Technical Support experts available for guidance
- Industry-leading quality system including ISO 17034 certification





Applications

Using your environmental isolate, we manufacture test-ready controls to help you meet USP guidelines including:

- Antimicrobial Effectiveness Testing - USP <51>
- Aseptic Processing Environment - USP <1116>
- Disinfectant Qualification - USP <116>
- Growth Promotion Testing - USP <61>, <62>, <71>
- Suitability Testing - USP <51>, <61>, <62>, <71>
- Validation of Neutralization Methods - USP <1227>
- Water for Pharmaceutical Purposes - USP <1231>

How It Works

- To get started, connect with our Custom Solutions team by filling out a contact form at microbiologics.com/custom-solutions or emailing custom@microbiologics.com. We'll reach out to provide more information on our services and to learn about your testing needs.
- Next, complete the Custom Solutions Request Form including details about your strain and test applications. We'll send a quote within 48 hours for your review and approval.
- A shipping box will be sent to your laboratory containing the supplies required to send us your isolate.
- When your strain arrives at our facility, it will be identified, preserved and manufactured in an easy-to-use format that best meets the needs of your laboratory.
- Our turnaround time is typically 6-8 weeks from the time we receive your isolate.

What's Included

- **Confidentiality:** All the strain information you share with us will remain proprietary.
- **Identification:** Your isolate will be identified phenotypically and genotypically.
- **Storage:** Our team will maintain stock cultures of your isolate for future use (banked at our headquarters).
- **Quality Guarantee:** Quality control will be performed on your custom controls prior to every shipment.
- **On-going Support:** If you have questions about your custom controls, our Technical Support team is available for guidance.



Custom Biological Controls Designed for Your Assay and Your Customers



Microbiologics Business Solutions is a service division of Microbiologics focused on developing internal and external controls tailored to new or existing diagnostic assays in the market.

In collaboration with platform and assay manufacturers, the controls provided by Microbiologics Business Solutions accelerate commercialization, simplify customer guidelines, and ensure an independent third-party provider for verification and QC of your diagnostic assays.

Why Microbiologics?

- We have developed and produced industry-leading products for over 45 years
- We are the leading experts in biological controls and possess the industry's highest accreditations
- We are easy to work with and agile to meet your continuously evolving requirements
- We are capable of delivering your products anywhere in the world through our vast global marketing and distribution system
- We are the only company with dedicated sales, marketing and technical support experts ready to answer questions and solve problems for you and your customers



Partner with Microbiologics to support assay development
from conception through commercialization



Manufacturing

- Custom manufacturing and packaging
- Scalable production capabilities
- FDA Registered Facility (CGMP)
- ISO 13485, ISO 17025 and ISO 17034



Preservation

- Multiple options for refrigerated or room temperature storage
- Lyophilized pellets
- Liquid suspensions



Formats

- Viable or inactivated organisms
- Synthetic nucleic acids
- Recombinant materials
- Singleplex or multiplex targets
- Ready-to-use packaging configurations

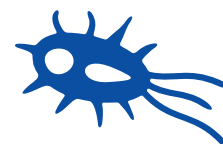

Targets

- Sourced from various collections (e.g., ATCC®, FDA, CDC)
- Proprietary strains
- Fully authenticated bacteria, parasites, fungi and viruses



Applications

- Sensitivity/Specificity
- Extraction/Amplification
- Presence/Absence
- Validation/Verification
- Proficiency/Training



Control Types

- Internal and external QC
- Routine QC
- Customized panels for verification and/or validation



Support

- Co-marketing/co-selling
- Global marketing and distribution



Compliance

- CE Mark
- *In Vitro* Diagnostic (IVD)
- Certified Reference Material

The Microbiologics Business Solutions team of dedicated specialists is ready to design, develop and deliver custom biological controls that support your assay and meet your customers' needs.

Leverage our extensive expertise, state-of-the-art manufacturing capabilities and a powerful global distribution network to reduce your time to market and increase customer adoption.

Customized Proficiency Testing Solutions for Your Lab



Proficiency providers and quality assurance/ quality control managers share a common goal: to maintain the highest quality standards in the laboratories they serve and oversee.

With more than 45 years of experience in developing innovative biological controls, Microbiologics provides leading solutions for proficiency testing. We combine our extensive microbiology expertise and advanced molecular technologies to provide comprehensive solutions that support your proficiency testing program.

Why Microbiologics?

- High quality, well characterized microorganisms
- Customized, flexible programs
- Broad range of control materials
- Strains from leading culture collections, customer submitted strains and additional strain material available upon request
- Certificate of Analysis and custom labeling available
- Susceptibility and statistical data available upon request
- Multiple markets serviced including clinical, food, water, beverage and cannabis
- Provide optional shipping and handling services that conform to IATA requirements with ability to support pre-scheduled, multi-site shipments



Targets:

- Bacteria
- Fungi
- Parasites
- Viruses
- Antigens

Applications:

- Microbial identification
- Enumeration methods
- Susceptibility testing
- Molecular programs

Formats:

- Single strain or mixed culture
- Viable or inactivated organisms
- Synthetic nucleic acids
- Microscopy slides



Choose from common proficiency testing panels or partner with us to create customized testing solutions for your lab. Contact our Proficiency Solutions team at proficiencyolutions@microbiologics.com to learn more.

Clinical PT:

- Acid Fast Slides
- Aspirate Cultures
- Bordetella
- Blood Culture
- BV Specimens
- C. difficile Culture and Toxin Detection
- Chlamydia/GC
- Chlamydia/GC/Strep B
- Cryptococcal/Giardia Antigens
- Eye/Ear Culture
- Fungal Serology
- GC (Neisseria gonorrhoeae)
- Gram Stain Slides
- Group B Strep Detection
- KOH Slides
- Legionella Survey
- MRSA (Culture)
- Mycobacterium Culture
- Mycology/Dermatophyte Specimens
- N. gonorrhoeae/Group B Strep
- Parasite Wet Mount
- PNU Specimens
- Sputum
- Stool
- Strep (Group A) Dry Antigens
- Throat
- Throat/Strep. pyogenes
- Urine
- Urine Colony Count
- Vaginitis Screen
- Viruses (For Molecular and Antigen Detection)
- VRE (Culture)
- Wound

Food PT:

- Anaerobic (Quantitative)
- Beverage Contaminants
- Campylobacter (Semi-Quantitative)
- Cronobacter (Qualitative)
- Food Mixed Cultures (Qualitative)
- Food Mixed Cultures (Quantitative)
- Food Pathogen Free Mixed Cultures (Quantitative)
- Food Pathogen Mixed Cultures (Quantitative)
- Lactic Acid (Quantitative)
- Listeria (Semi-Quantitative)
- Meat Matrix
- Milk Matrix
- Pseudomonas (Semi-Quantitative)
- Salmonella (Qualitative)
- Shiga Toxin (STEC) (Qualitative)
- Vibrio (Qualitative)

Water PT:

- Coliform (Qualitative)
- Coliform (Quantitative)

Pharma PT:

- Microbial Enumeration Testing
- Sterility Testing
- Growth Promotion Testing

General PT:

- Bacteriology
- Blank Cultures (Negative)
- Environmental Bacteria/Fungus

Molecular PT:

- Influenza A and Influenza B
- Respiratory Panels
- GI Panels
- Herpes Simplex Virus (HSV) 1 and 2
- Trichomonas vaginalis

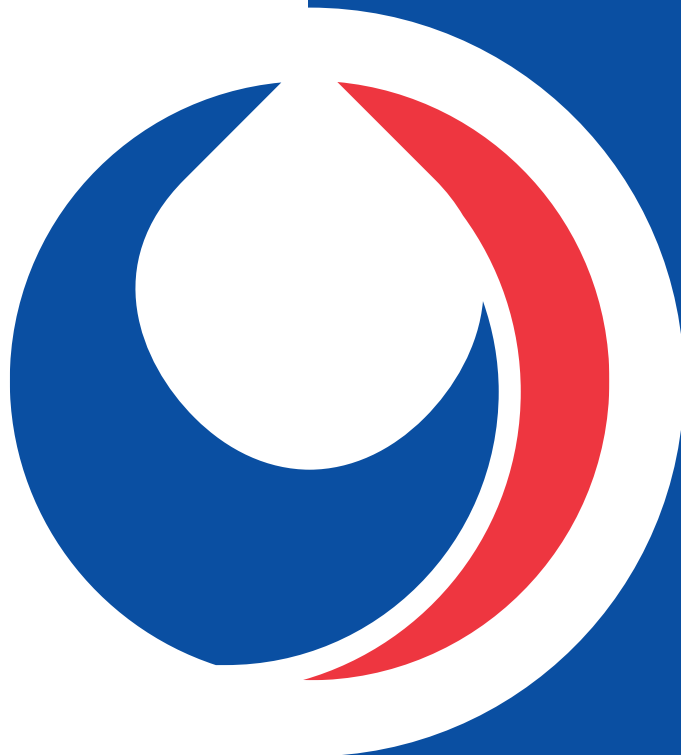

 **Microbiologics®**

A safer, healthier world.

200 Cooper Avenue North | St. Cloud, MN 56303

+1.320.253.1640 | 1.800.599.BUGS(2847)

info@microbiologics.com | microbiologics.com